

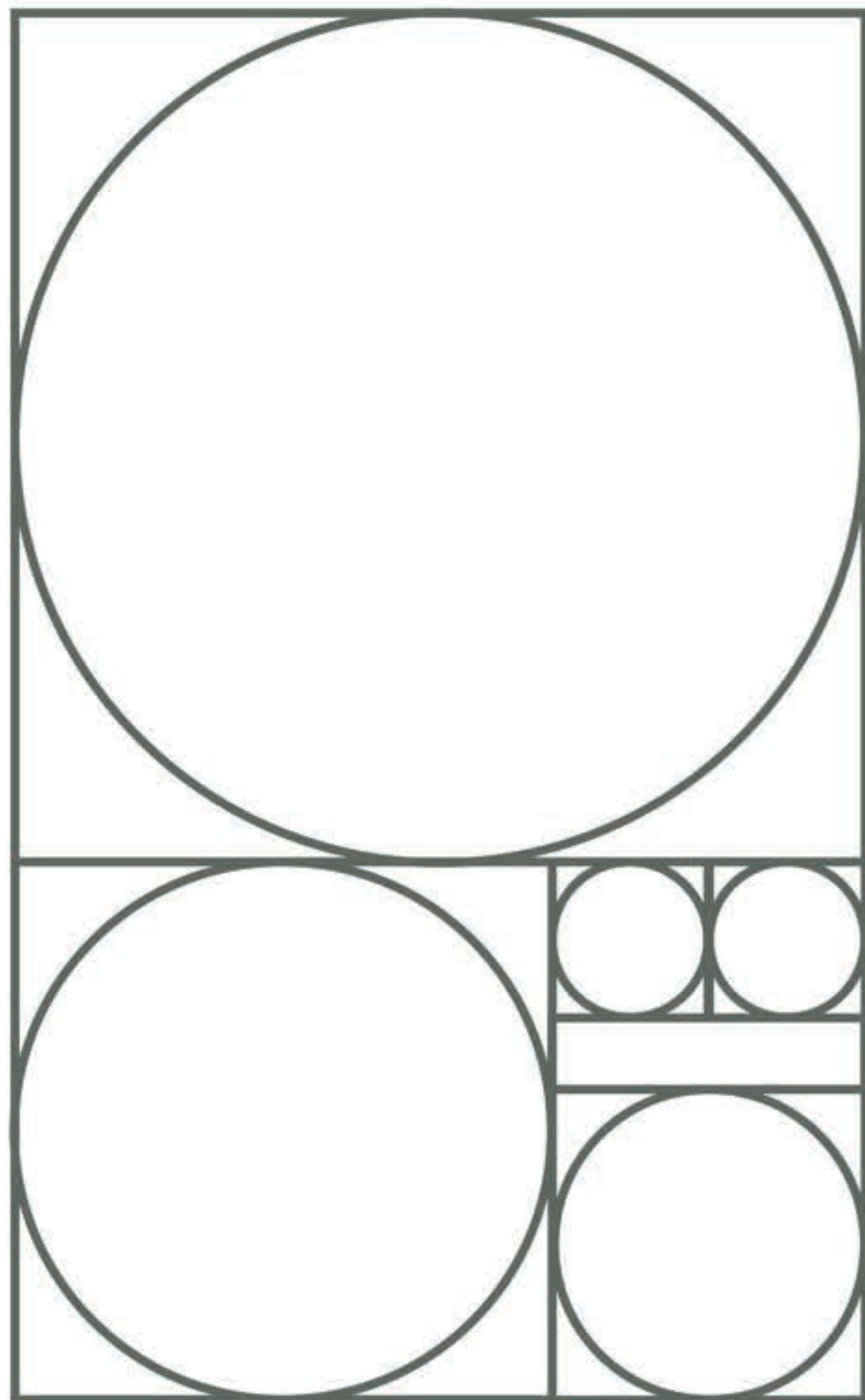

www.aureabath.com



indice
index

Empresa	4 - 29
Azienda • Société • Company	
Platos de ducha	30 - 87
Piatti doccia • Receveurs de douche • Shower trays	
Paneles de revestimiento	88 - 95
Pannelli rivestimento • Panneaux de revêtement • Cladding panels	
Encimeras	96 - 103
Top • Plans de toilette • Worktops	
Lavabos	104 - 113
Lavabi • Vasques • Basins	
Cajoneras	114 - 115
Cassettiere • Tiroirs • Drawers	
Bañeras	116 - 121
Vasche da bagno • Baignoires • Bathtubs	
Corian	122 - 139
Aurea Deko	140 - 181
Información técnica	182 - 191
Informazioni tecniche • Information technique • Technical information	



Innovación • Innovazione Innovation • Innovation

La empresa Aurea Bath atesora una dilatada experiencia acumulada a lo largo de los años, en la fabricación de materiales compuestos. Desde mediados del 2022, el fundador de McBath, Ricardo Murria, participa en el accionariado de Aurea Bath, junto con la empresa asociada Sanycces. Ambas marcas, referentes en el sector del baño, aúnan capacidades productivas, habilidades y conocimientos complementarios, que se concretan en la puesta en marcha de nuevos proyectos y la implantación de la tecnología más vanguardista.

Aurea Bath vanta di una grande esperienza accumulata negli anni nella produzione di materiali compositi. Dalla metà del 2022, il fondatore di McBath, Ricardo Murria, è azionista di Aurea Bath, insieme alla società Sanycces. Entrambi i marchi, punti di riferimento nel settore del bagno, uniscono capacità produttive, competenze e conoscenze complementari che si concretizzano nella realizzazione di nuovi progetti e nell'implementazione delle tecnologie più all'avanguardia.

La société Aurea Bath possède une vaste expérience accumulée au fil des ans dans la fabrication de matériaux composites. Depuis mi-2022, le fondateur de McBath, Ricardo Murria, participe à l'actionariat d'Aurea Bath, avec la société associée Sanycces. Les deux marques, références dans le secteur de la salle de bain, allient des capacités productives, des compétences et des savoir-faire complémentaires, qui se concrétisent dans la mise en œuvre de nouveaux projets et l'implantation des technologies les plus pointues.

The company Aurea Bath treasures a vast experience accumulated over the years in the manufacture of composite materials. Since mid-2022, the founder of McBath, Ricardo Murria, participates in the shareholding of Aurea Bath, along with the associated company Sanycces. Both brands, leaders in the bathroom sector, combine productive capacities, skills and complementary knowledge, which are embodied in the implementation of new projects and the most cutting-edge technology.



Calidad • Qualita Qualité • Quality

Aurea Bath cuenta con su propio Laboratorio de Control de Materias Primas, capacitado para realizar tests de resbaladiezidad y pruebas específicas del sector que nos facultan para garantizar la máxima calidad de nuestros productos.

Aurea Bath dispone di un proprio laboratorio di controllo delle materie prime, in grado di effettuare test di scivolosità e prove specifiche per il settore che ci permettono di garantire la massima qualità dei nostri prodotti.

Aurea Bath dispose de son propre Laboratoire de Contrôle des Matières Premières, qualifié pour effectuer des tests de glissement et des tests spécifiques au secteur, qui nous permettent de garantir la plus haute qualité de nos produits.

Aurea Bath has its own Raw Materials Control Laboratory, trained to perform slipperiness tests and sector-specific tests that allow us to guarantee the highest quality of our products.

Objetivos • Obbiettivi Objectifs • Targets

Nuestro objetivo principal es garantizar la Excelencia en la Calidad y el Servicio a nuestros clientes . Para ello contamos con un equipo multidisciplinar de nueva creación , con profesionales procedentes de los sectores más exigentes de la industria.

Il nostro obiettivo principale è garantire ai nostri clienti l'eccellenza della qualità e del servizio. A tal fine , abbiamo creato un team multidisciplinare , con professionisti provenienti dai settori più esigenti dell'industria.

Notre objectif principal est de garantir l'Excellence de la Qualité et du Service à nos clients. Pour cela, nous avons une équipe multidisciplinaire nouvellement créée , avec des professionnels provenant des secteurs les plus exigeants de l'industrie.

Our main objective is to guarantee Excellence in Quality and Service to our customers. For this we have a newly created multidisciplinary team, with professionals from the most demanding sectors of the industry.





Creatividad • Créativité Créativité • Creativity

La creatividad en Aurea se beneficia de la sinergia y colaboración con las empresas del sector tecnológico más importantes de Europa. Contamos con el apoyo de la tecnología Deko. Gracias a nuestra implicación y compromiso en I+D somos capaces de desarrollar nuevos materiales como el Nitragel®.

Nuestro lema: La Mejora Continua.

La creatività di Aurea trae vantaggio dalla sinergia e dalla collaborazione con le principali aziende tecnologiche europee. Siamo supportati dalla tecnologia Deko. Grazie al nostro coinvolgimento e impegno nella ricerca e sviluppo, siamo in grado di sviluppare nuovi materiali come il Nitragel®.

Il nostro motto: miglioramento continuo.

Chez Aurea Bath, la créativité bénéficie de la synergie et de la collaboration avec les entreprises les plus importantes du secteur technologique en Europe. Nous avons l'appui de la technologie Deko. Grâce à notre implication et à notre engagement dans la R+D, nous sommes en mesure de développer de nouveaux matériaux tels que le Nitragel®.

Notre slogan: L'Amélioration Continue

Creativity at Aurea benefits from synergy and collaboration with the most important companies in the technology sector in Europe. We are supported by Deko technology. Thanks to our involvement and commitment in R+D we are able to develop new materials such as Nitragel®.

Our motto: Continuous Improvement



AUREA SOLUTIONS TO
INNOVATE AND ENHANCE
YOUR BATHROOM

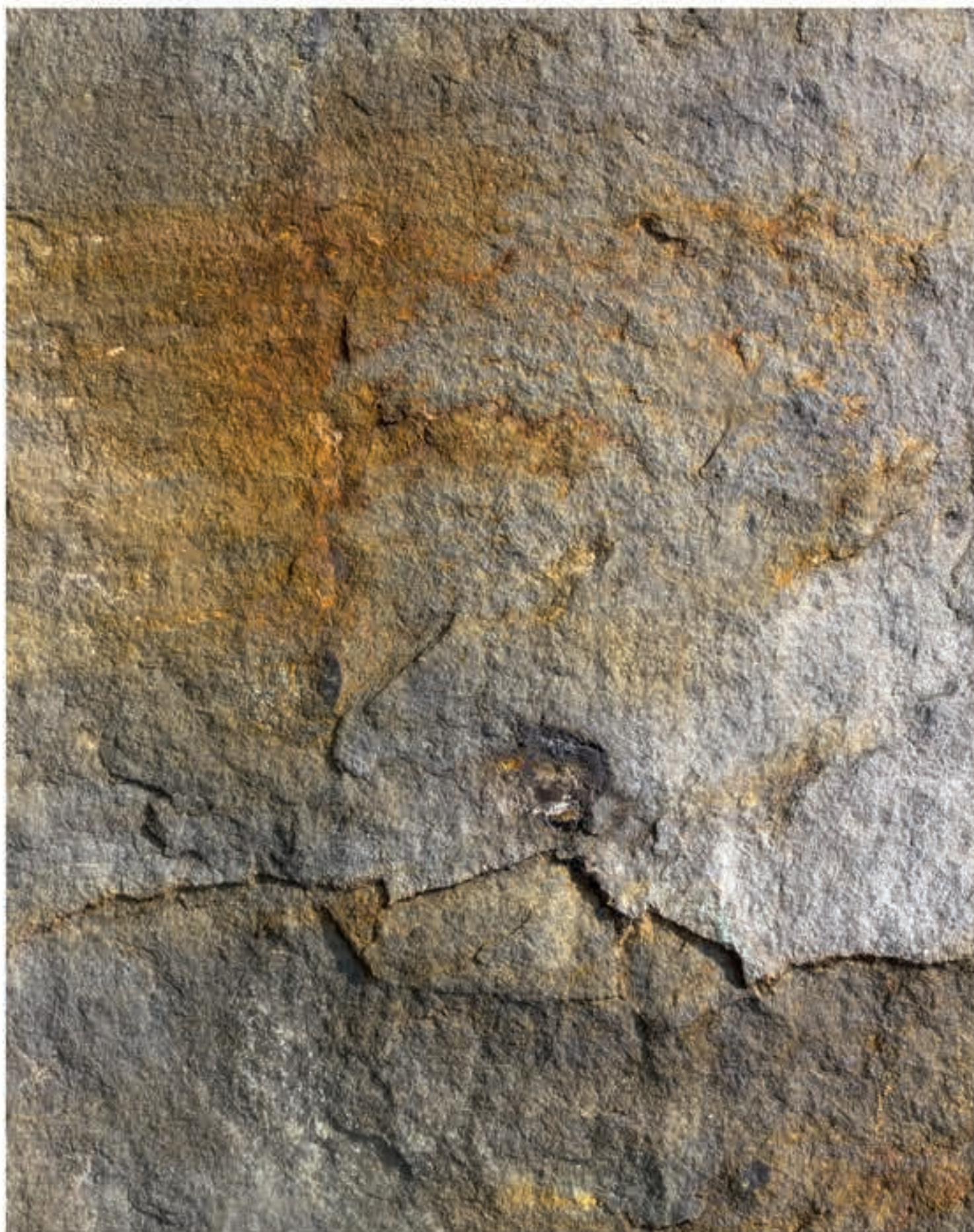

Inspiración • Ispirazione Inspiration • Inspiration

En este nuevo catálogo hemos reunido los colores de mayor actualidad, inspirándonos en los ambientes urbanos y de la naturaleza, e incorporado nuevas texturas como el "Stucco".

In questo nuovo catalogo abbiamo aggiunto i colori più alla moda, ispirati agli ambienti urbani e naturali, e incorporato nuove texture come lo "Stucco".

Dans ce nouveau catalogue, nous avons ajouté les couleurs les plus en vogue, inspirées des environnements urbains et naturels, et nous avons incorporé de nouvelles textures telles que le "Stucco".

In this new catalog we have added the most current colors, inspired by urban environments and nature, and we have incorporated new textures such as the "Stucco".

Texturas • Finiture

Textures • Textures

Aurea ofrece las texturas más novedosas del mercado. La combinación de estas texturas con los acabados de nuestra gama DEKO marcan la diferencia, adaptándose a las tendencias más vanguardistas en el diseño del ambiente del baño.

Aurea offre le texture più innovative del mercato. La combinazione di queste texture con le finiture della nostra gamma DEKO fa la differenza, adattandosi alle tendenze più all'avanguardia del design del bagno.

Aurea offre les textures les plus innovantes du marché. La combinaison de ces textures avec les finitions de notre gamme DEKO fait la différence, en s'adaptant aux tendances les plus avant-gardistes dans le design de l'ambiance de la salle de bain.

Aurea offers the most innovative textures on the market. The combination of these textures with the finishes of our DEKO range make the difference, adapting to the most avant-garde trends in the design of the bathroom environment.





Nitragel 

NITRAGEL® es un material formado por un Polímero Acrílico con Nano-tecnología en su composición de partículas de plata y microesferas, lo que le confiere propiedades anti-bacterianas y anti-deslizantes, aportando las cualidades esenciales, como la resistencia a la hidrólisis, entre otras, que garantizan la excepcional calidad del producto final

NITRAGEL® è un materiale formato da un polimero acrilico con una nano-tecnologia nella sua composizione di particelle d'argento e microsferi, che gli conferisce proprietà antibatteriche e antiscivolo, fornendo le qualità essenziali, come la resistenza all'idrolisi, tra le altre, che garantiscono l'eccezionale qualità del prodotto finale.

NITRAGEL® est un matériau composé d'un Polymère Acrylique avec de la Nano-technologie dans sa composition de particules d'argent et de microsphères, ce qui lui confère des propriétés antibactériennes et antidérapantes, en apportant les qualités essentielles, comme la résistance à l'hydrolyse, entre autres, qui garantissent la qualité exceptionnelle du produit final.

NITRAGEL® is a material formed by an Acrylic Polymer with Nano-technology in its composition of silver particles and microspheres, which gives it anti-bacterial and anti-slip properties, providing the essential qualities, such as resistance to hydrolysis, among others, that guarantee the exceptional quality of the final product.



Solid Coat

SolidCoat es un material constituido por un alto porcentaje de cargas minerales naturales, y a su vez, con un bajo porcentaje de polímeros poliésteres. Recubierto por una capa exterior de Gelcoat, se convierte en una opción ideal para el baño, gracias a su excelente resistencia a las agresiones químicas derivadas del uso cotidiano en el hogar.

SolidCoat è un materiale composto da un'alta percentuale di cariche minerali naturali, con una bassa percentuale di polimeri di poliestere. Rivestito con uno strato esterno di Gelcoat, diventa la scelta ideale per il bagno, grazie alla sua eccellente resistenza alle aggressioni chimiche derivanti dall'uso quotidiano in casa.

SolidCoat est un matériau composé d'un pourcentage élevé de charges minérales naturelles et, à son tour, d'un faible pourcentage de polymères de polyester. Recouvert d'une couche extérieure de Gelcoat, il devient une option idéale pour la salle de bain, grâce à son excellente résistance aux agressions chimiques découlant de l'utilisation quotidienne à la maison.

SolidCoat is a material consisting of a high percentage of natural mineral fillers, and in turn, with a low percentage of polyester polymers. Covered by an outer layer of Gelcoat, it becomes an ideal choice for the bathroom, thanks to its excellent resistance to chemical aggressions derived from daily use at home.

Colores
Colori
Couleurs
Colors

Nitragei

OTTANIO



NUDE



CORDA



AVANA



SETA



ALBA



ARGILLA



CEMENTO



ANTRACITA

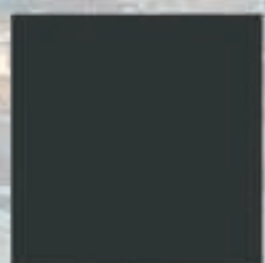

NEVE



TERRA



VERONA





Sabores de la tierra
Sapori della terra

Saveurs de la terre
Flavours of the land

Nitragel 

CORDA



AVANA



SETA

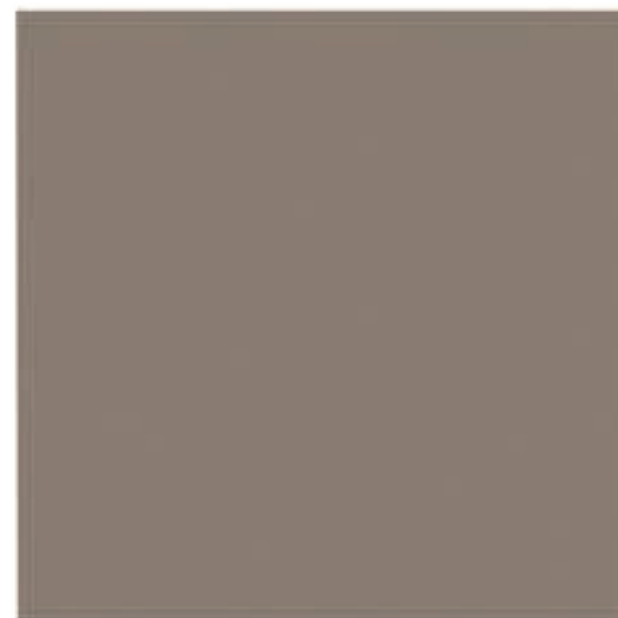

TERRA





Espíritu urbano
Spirito urbano

Esprit urbain
Urban spirit

Nitrageil 

ALBA



ARGILLA



CEMENTO



ANTRACITA





Nueva generación
Nuova generazione

Nouvelle génération
New generation

Nitragel 

NEVE

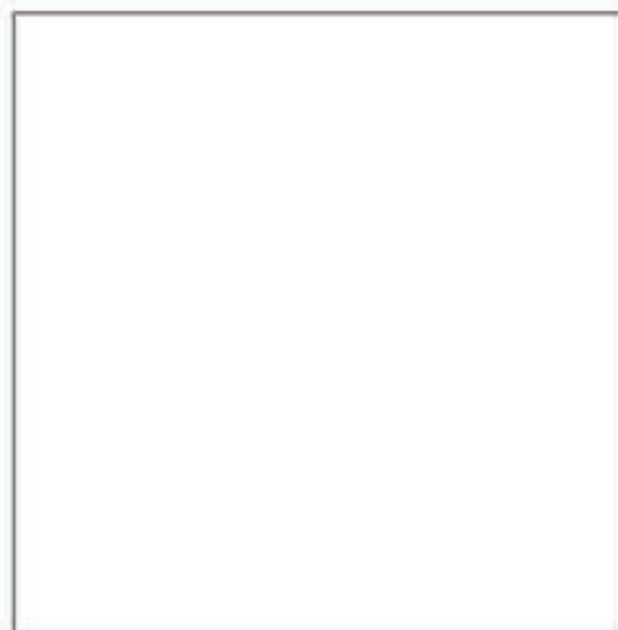

OTTANIO

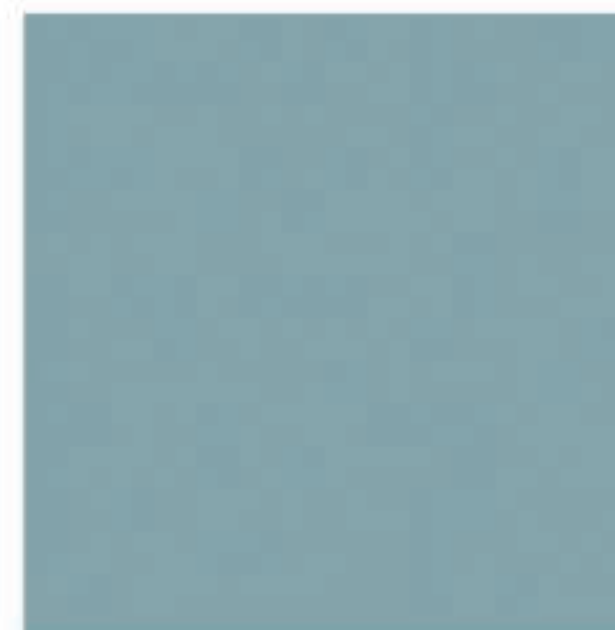

NUDE



VERONA





Platos de ducha
Piatti doccia
Receveurs de douche
Shower trays



AUREA

Materia

Seguendo la estela del plato de ducha Essential, MATERIA consigue unificar todo el plato de ducha bajo un mismo material. La textura "Stone" se extiende así por toda la superficie del plato, ofreciendo una sensación de armonía y continuidad al diseño.

Seguendo le orme del piatto doccia Essential, MATERIA riesce a unificare l'intero piatto doccia sotto lo stesso materiale. La finitura "Stone" si estende su tutta la superficie, regalando un senso di armonia e continuità al disegno.

En suivant le sillage du receveur de douche Essential, MATERIA réussit à unifier l'ensemble du receveur de douche sous un même matériau. La texture "Stone" s'étend ainsi sur toute la surface du receveur de douche en offrant au design une sensation d'harmonie et de continuité.

Following the trail of the shower tray Essential, MATERIA manages to unify the entire shower tray under the same material. The "Stone" texture thus spreads over the entire surface of the shower tray, bringing a sense of harmony and continuity to the design.



	80	90	100	110	120	130	140	150	160	170	180	190	200
70		•	•	•	•	•	•	•	•	•	•	•	•
80		•	•	•	•	•	•	•	•	•	•	•	•
90		•	•	•	•	•	•	•	•	•	•	•	•
100		•	•	•	•	•	•	•	•	•	•	•	•

Textura / Finitura / Textures / Textures

STONE

Incluida / Compresa / Include / Included



Plato ducha Materia textura Stone color blanco Neve • Piatto doccia Materia finitura Stone colore bianco Neve
Receveur de douche Materia texture Stone couleur blanc Neve • Shower tray Materia Stone texture color white Neve



Plato ducha Materia con panel de revestimiento textura Stone y lavabo Tasos color Terra
Piatto doccia Materia con pannello rivestimento finitura Stone e lavabo Tasos color Terra
Receveur de douche Materia avec panneau de revêtement en texture Stone avec lavabo Tasos couleur Terra
Shower tray Materia with a wall cladding panel in a Stone texture and washbasin Tasos in Terra color.

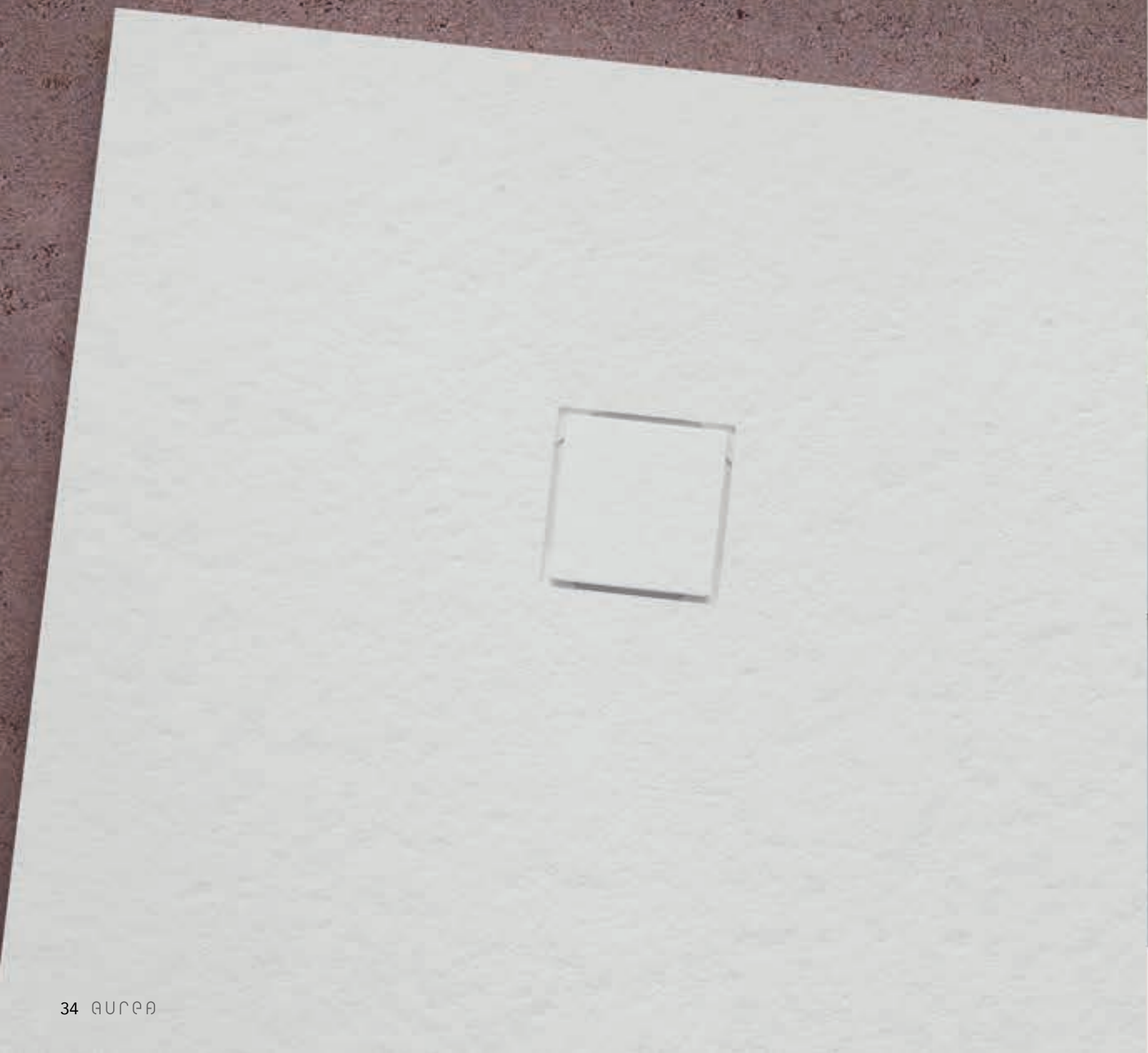



Plato doccia Materia texture Stone color Alba • Platto doccia Materia finitura Stone colore Alba
Receveur de douche Materia texture Stone couleur Alba • Shower tray Materia Stone texture color Alba

Calatrava

A petición de las tendencias del mercado, la serie CALATRAVA se presenta como una variante del plato convencional, adoptando un diseño que gracias a su válvula oculta consigue dar un acabado moderno al entorno del baño.

Sulla scia delle tendenze del mercato, la serie CALATRAVA si presenta come un'opzione al piatto doccia convenzionale adottando, attraverso la sua pillotta di scarico nascosta, un design eccezionale con una finitura moderna per l'arredo bagno.

À la demande des tendances du marché, la série CALATRAVA se présente comme une variante du receveur de douche conventionnel en adoptant un design qui, grâce à sa bonde cachée, donne une finition moderne au décor de la salle de bain.

In the wake of market trends, the CALATRAVA series shows up as an option to the conventional shower tray adopting, through its hidden drain valve, an outstanding design featuring a modern finish to the bathroom decor.



	80	90	100	110	120	130	140	150	160	170	180	190	200
70	•	•	•	•	•	•	•	•	•	•	•	•	•
80		•	•	•	•	•	•	•	•	•	•	•	•
90		•	•	•	•	•	•	•	•	•	•	•	•
100		•	•	•	•	•	•	•	•	•	•	•	•

Textura / Finitura / Textures / Textures

STONE

Incluida / Compresa / Include / Included

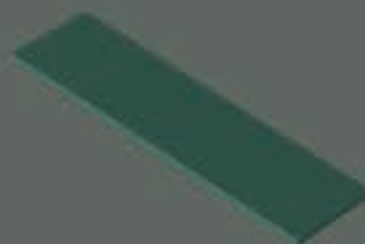



Plato doccia Calatrava texture Stone color bianco Neve • Platto doccia Calatrava finitura Stone colore bianco Neve
Receveur de douche Calatrava texture Stone couleur blanc Neve • Shower tray Calatrava Stone texture color white Neve





Plato ducha Calatrava textura Stone y lavabo Hidra color Verona
Piatto doccia Calatrava finitura Stone e lavabo Hidra color Verona
Réceveur de douche Calatrava en texture Stone avec lavabo Hidra couleur Verona
Shower tray Calatrava in a Stone texture and washbasin Hidra in Verona color

Cover

El diseño de la colección COVER conjuga elegancia y comodidad. Se distingue por su fácil ambientación en cualquier espacio, bien sea tradicional o nada convencional. Su sistema de desagüe por desbordamiento hace que la válvula quede oculta a la vista. Disponible en textura Pizarra o Liso.

Il design della collezione COVER unisce eleganza e comfort. Si distingue per le sue linee semplici, ed è adattabile in ogni stanza, sia tradizionale e non convenzionale. Il suo sistema di drenaggio del troppopieno nasconde alla vista la piletta di scarico. Disponibile nelle finiture Ardesia e Liscia.

Le design de la collection COVER allie élégance et confort. Il se démarque par son décor facile dans n'importe quelle pièce, qu'elle soit traditionnelle ou non conventionnelle. Son système de drainage par débordement rend la bonde invisible à l'œil. Disponible en textures Ardoise et Lisse.

The design of the COVER collection combines elegance and comfort. It stands out by its easy decor in any room, whether traditional or unconventional. Its overflow drainage system hides the drain valve to the eye. Available in Slate and Smooth textures.

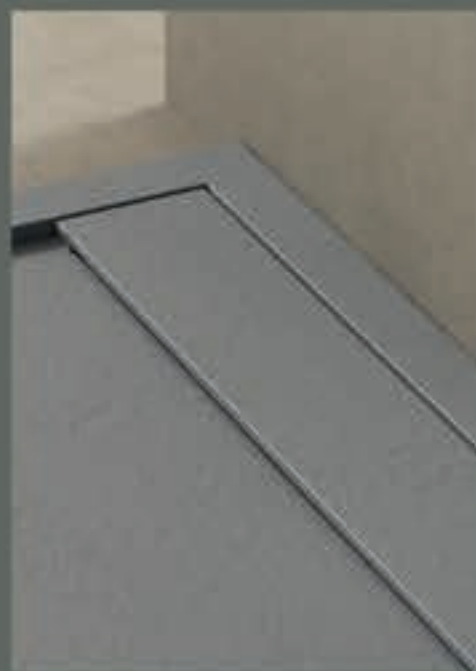

	80	90	100	110	120	130	140	150	160	170	180	190	200
70			•	•	•	•	•	•	•	•	•	•	•
80			•	•	•	•	•	•	•	•	•	•	•
90			•	•	•	•	•	•	•	•	•	•	•
100			•	•	•	•	•	•	•	•	•	•	•

Textura / Finitura / Textures / Textures

Pizarra/Ardesia/Ardoise/Slate

Liso/Liscio/Lisse/Smooth

Incluida / Compresa / Incluse / Included





Plato ducha Cover textura Pizarra color Antracita • Piatto doccia Cover finitura Ardesia colore Antracita
Receveur de douche Cover texture Ardoise couleur Antracita • Shower tray Calatrava Slate texture color Antracita

Plato ducha Cover textura Lisa color Corda • Piatto doccia Cover finitura Liscia colore Corda
Receveur de douche Cover texture Lisse couleur Corda • Shower tray Cover Smooth texture color Corda



Nevo

El plato de ducha NEVO nace de la piedra más selecta. La sutileza de su textura superficial ofrece la posibilidad de crear baños sobrios y distinguidos.

Il piatto doccia NEVO nasce dalla pietra più pregiata. La finezza della sua trama superficiale offre la possibilità di creare bagni sobri e distinti.

Le receveur de douche NEVO est né de la pierre la plus raffinée. La subtilité de sa texture en surface offre la possibilité de créer des salles de bains sobres et distinguées.

The NEVO shower tray is made out of the daintiest stone. The fineness of its surface texture offers the possibility of creating restrained and classy bathrooms.



	80	90	100	110	120	130	140	150	160	170	180	190	200
70		•	•	•	•	•	•	•	•	•	•	•	•
80		•	•	•	•	•	•	•	•	•	•	•	•
90		•	•	•	•	•	•	•	•	•	•	•	•

Textura / Finitura / Textures / Textures

STONE

Incluida / Compresa / Incluse / Included





Plato doccia Nevo textura Stone color Argilla • Piatto doccia Nevo finitura Stone colore Argilla
Receveur de douche Nevo texture Stone couleur Argilla • Shower tray Nevo Stone texture color Argilla



Plato ducha Nevo textura Stone , lavabo Samos y cajonera color Blanco Neve
Piatto doccia Nevo finitura Stone ,lavabo Samos e cassetiera colore Bianco Neve
Receveur de douche Nevo en texture Stone lavabo et meuble à tiroirs Samos en Blanc Neve
Nevo shower tray in Stone finish, Samos washbasin and drawer unit in Neve White colour



Urban

Los platos de ducha URBAN simplifican su forma en un solo material, otorgándole un aspecto impecable y sofisticado. El sifón permanece perfectamente accesible y su evacuación de agua es precisa. Además, la textura STONE le hará sentir una sensación única bajo tus pies.

I piatti doccia URBAN semplificano la loro forma in un solo materiale, conferendogli un aspetto unico e sofisticato. Il sifone rimane perfettamente accessibile e lo scarico dell'acqua perfetto. Inoltre la finitura STONE ti farà sentire una sensazione unica sotto i tuoi piedi.

Le receveur de douche URBAN simplifie sa forme dans un seul matériau, ce qui lui confère un aspect impeccable et sophistiqué. Le siphon reste parfaitement accessible et son évacuation d'eau est précise. De plus, la texture STONE vous fera ressentir une sensation unique sous vos pieds.

URBAN shower trays simplify their shape in a single material, giving it a flawless and sophisticated look. The siphon remains perfectly accessible and its water drainage is accurate. In addition, the STONE texture will make you feel a unique sensation under your feet.



	80	90	100	110	120	130	140	150	160	170	180	190	200
70		•	•	•	•	•	•	•	•	•	•	•	•
80		•	•	•	•	•	•	•	•	•	•	•	•
90		•	•	•	•	•	•	•	•	•	•	•	•

Textura / Finitura / Textures / Textures

STONE

Incluida / Compresa / Include / Included





Plato ducha Urban textura Stone color Argilla • Piatto doccia Urban finitura Stone colore Argilla
 Receveur de douche Urban texture Stone couleur Argilla • Shower tray Urban Stone texture color Argilla



Plato ducha Urban textura Stone color Corda
 Piatto doccia Urban finitura Stone colore Corda
 Receveur de douche Urban texture Stone couleur Corda
 Shower tray Urban Stone texture color Corda



Plato ducha Urban textura Stone color Ottanio
 Piatto doccia Urban finitura Stone colore Ottanio
 Receveur de douche Urban texture Stone couleur Ottanio
 Shower tray Urban Stone texture color Ottanio

Stucco

La textura de nuestros platos de ducha STUCCO permite conectar con un estado de serenidad por medio de la estética en crudo y estéticas del pasado como es el estilo industrial. Disponible con rejilla de acero inox o tapa en resina.

La texture dei nostri piatti doccia STUCCO permette di entrare in contatto con uno stato di serenità attraverso un'estetica rustica e un'estetica del passato, come lo stile industriale. Disponibile con copripiletta in acciaio inox o copripiletta in resina dello stesso materiale del piatto.

La texture de nos receveurs de douche STUCCO permet de se rapprocher d'un état de sérénité au moyen de l'esthétique brute et des esthétiques d'autrefois, notamment le style industriel. Disponible avec grille en acier inox ou en résine du même matériau que le receveur de douche.

The texture of our STUCCO shower trays enables the connection with a peacefulness mindset by means of the raw aesthetic and the aesthetic of yore, as the industrial style. Grid available in either stainless steel or resin of the same material as the shower tray.



	80	90	100	110	120	130	140	150	160	170	180	190	200
70		•	•	•	•	•	•	•	•	•	•	•	•
80			•	•	•	•	•	•	•	•	•	•	•
90				•	•	•	•	•	•	•	•	•	•
100					•	•	•	•	•	•	•	•	•

Textura / Finitura / Textures / Textures

STUCCO

Incluida / Compresa / Include / Included		
	Cover	Inox
		





Piatta doccia Stucco texture Stucco color Cemento • Piatta doccia Stucco finitura Stucco color Cemento
 Receveur de douche Stucco texture Stucco couleur Cemeniio • Shower tray Stucco , texture Stucco color Cemento



Stucco Cover



Stucco Inox



Plato doccia Stucco Cover, bañera Santorini, lavabo Samos y cajonera color Argilla
Piatto doccia Stucco Cover, vasca Santorini, top Inscatolato Samos e cassettera colore Argilla
Receveur de douche Stucco Cover, baignoire Santorini, plan de toilette Samos et tiroir en couleur Argilla
Shower tray Stucco Cover, bathtub Santorini, countertop Samos and drawer unit in Argilla color

Stucco Project

Siguiendo la estela del plato de ducha Stucco, el plato de ducha Stucco Project se entrega al diseño minimalista. La característica principal es la posición lateral de su válvula que presenta un toque exclusivo y moderno.

Seguendo le orme del piatto doccia Stucco, il piatto doccia "Stucco Project" abbraccia un design minimalista. La caratteristica principale è la posizione laterale della sua valvola che presenta un tocco esclusivo e moderno.

En suivant le sillage du receveur de douche Stucco, le receveur de douche "Stucco Project" se consacre au design minimaliste. Sa caractéristique principale est le positionnement latéral de sa bords, qui ajoute une touche exclusive et moderne.

Following the trail of the shower tray Stucco, the shower tray "Stucco Project" devotes to a minimalist design. Its main feature, a side position drain valve, provides an exclusive and modern feel.



	80	90	100	110	120	130	140	150	160	170	180	190	200
70			•	•	•	•	•	•	•	•	•	•	•
80			•	•	•	•	•	•	•	•	•	•	•
90			•	•	•	•	•	•	•	•	•	•	•
100			•	•	•	•	•	•	•	•	•	•	•

Textura / Finitura / Textures / Textures

STUCCO

Incluida / Compresa / Incluse / Included





Plato doccia Stucco Project texture Stucco y lavabo Tasos color Ottanio
Piatto doccia Stucco Project finitura Stucco e lavabo Tasos color Ottanio
Réceveur de douche Stucco Project en texture Stucco avec lavabo Tasos couleur Ottanio
Shower tray Stucco Project in a Stucco texture and washbasin Tasos in Ottanio color



Plato ducha Stucco Project textura Stucco color Cemento • Plato doccia Stucco Project finitura Stucco colore Cemento
 Receveur de douche Stucco Project texture Stucco couleur Cemento • Shower tray Stucco Project Stucco texture color Cemento



Look

LOOK es un plato de ducha concebido para evitar el desbordamiento del agua en cuartos de baño minimalistas, donde este requisito sea indispensable.

LOOK è un piatto doccia pensato per evitare lo straripamento dell'acqua nei bagni minimalisti, dove questa esigenza è indispensabile.

LOOK est un receveur de douche conçu pour éviter le débordement de l'eau dans les salles de bains minimalistes, où cette exigence est indispensable.

LOOK is a shower tray designed to prevent water overflowing in minimalist bathrooms, where this requirement is imperative.



	80	90	100	110	120	130	140	150	160	170
70		•			•		•	•	•	•
80			•		•		•	•	•	•
90	•	•		•		•	•	•	•	•

Textura / Finitura / Textures / Textures

Pizarra/Ardesia/Ardoise/Slate

Incluida / Compresa / Incluse / Included



Plato ducha Look, lavabo Samos y cajonera color Blanco Neve • Piatto doccia Look, top inscatolato Samos e cassetiera colore Bianco Neve
Receveur de douche Look, plan de toilette Samos et tiroirs Blanc Neve • Shower tray Look, countertop Samos and drawer unit White Neve



Plato ducha Look textura Pizarra color Antracita
Piatto doccia Look finitura Ardesia colore Antracita
Receveur de douche Look texture Ardoise couleur Antracita
Shower tray Look Slate texture color Antracita

Essential

Calidad y diseño único en cada rincón que se adapta a todos los espacios: El plato de ducha ESSENTIAL nació con la identidad del "hecho a medida" y este rasgo sigue formando parte de nuestra esencia. Naturalidad y simplicidad que se consiguen combinando las texturas Pizarra, Stone y Liso.

Qualità e design unico in ogni angolo si adattano a tutte le stanze. Il piatto doccia ESSENTIAL nasce con un'identità "su misura" e questa caratteristica rimane parte della nostra essenza. Naturalità e semplicità ottenute combinando le finiture Ardesia, Stone e Liscio.

Qualité et design unique dans chaque coin qui s'adaptent à toutes les pièces. Le receveur de douche ESSENTIAL est né avec l'identité du "fait sur mesure" et ce trait fait toujours partie de notre essence. Naturalité et simplicité atteints en combinant les textures Ardoise, Stone et Lisse.

Quality and one of a kind design in every corner fit in all rooms. ESSENTIAL shower tray was born with a "made-to-measure" identity and this feature still remains part of our essence. Naturalness and simplicity achieved by combining Slate, Stone and Smooth textures.



	80	90	100	110	120	130	140	150	160	170	180	190	200	210	220
70		•	•	•	•	•	•	•	•	•	•	•	•	•	•
75		•	•	•	•	•	•	•	•	•	•	•	•	•	•
80	•	•	•	•	•	•	•	•	•	•	•	•	•	•	•
90		•	•	•	•	•	•	•	•	•	•	•	•	•	•
100			•	•	•	•	•	•	•	•	•	•	•	•	•
110				•	•	•	•	•	•	•	•	•	•	•	•
120					•	•	•	•	•	•	•	•	•	•	•

• Medidas disponibles solo para textura Pizarra - Misure disponibili solo per finitura Ardesia

Dimensions disponibles uniquement dans la texture Ardoise - Measurements available only in Slate texture

Textura / Finitura / Textures / Textures

Pizarra/Ardesia/Ardoise/Slate • Stone • Liso/Liscio/Lisse/Smooth

Incluida / Compresa / Incluse / Included





Plato ducha Essential textura Pizarra color Terra
Piatto doccia Essential finitura Ardesia colore Terra
Receveur de douche Essential texture Ardoise couleur Terra
Shower tray Essential Slate texture color Terra

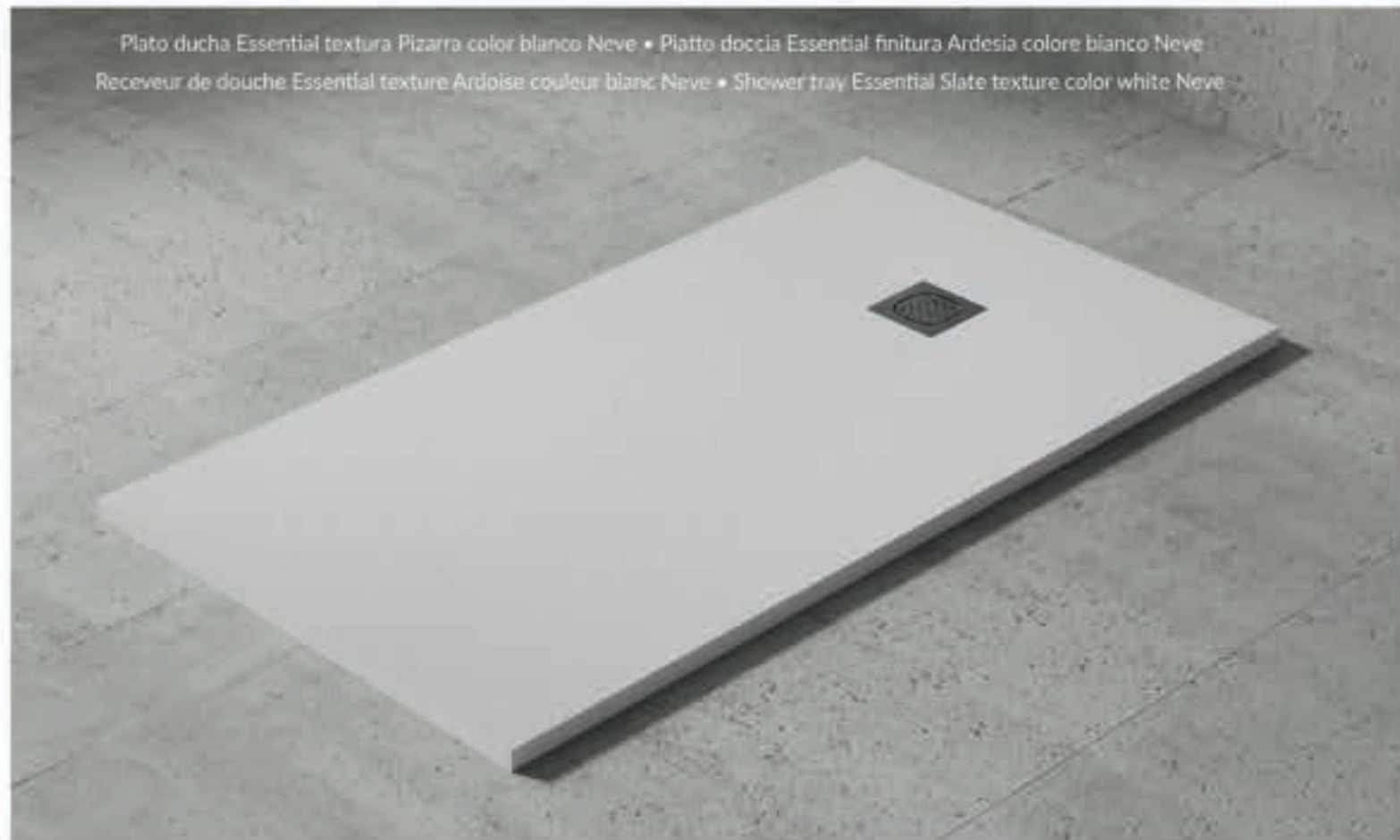

Plato ducha Essential textura Pizarra color blanco Neve • Piatto doccia Essential finitura Ardesia colore bianco Neve
Receveur de douche Essential texture Ardoise couleur blanc Neve • Shower tray Essential Slate texture color white Neve



Plato ducha Essential textura Pizarra y lavabo Milos color Argilla • Platto doccia Essential finitura Ardesia e lavabo Milos colore Argilla
Receveur de douche Essential texture Ardoise avec lavabo Milos couleur Argilla • Shower tray Essential Slate texture with Milos washbasin color Argilla





Plato ducha Essential Angular R-50 textura Stone color blanco Neve • Piatto doccia Essential angolare R-50 finitura Stone colore bianco Neve
Receveur de douche Essential Angulaire R-50 texture Stone couleur blanc Neve • Shower tray Essential Corner R-50 Stone texture color white Neve



Plato ducha Essential Angular R-55 textura Stone color Alba • Piatto doccia Essential angolare R-55 finitura Stone colore Alba
Receveur de douche Essential Angulaire R-55 texture Stone couleur Alba • Shower tray Essential Corner R-55 Stone texture color Alba





Plato ducha Essential textura Liso color Argilla • Piatto doccia Essential finitura Liscio colore Argilla

Receveur de douche Essential en texture Lisse couleur Argilla • Shower tray Essential in a Smooth texture in Argilla color



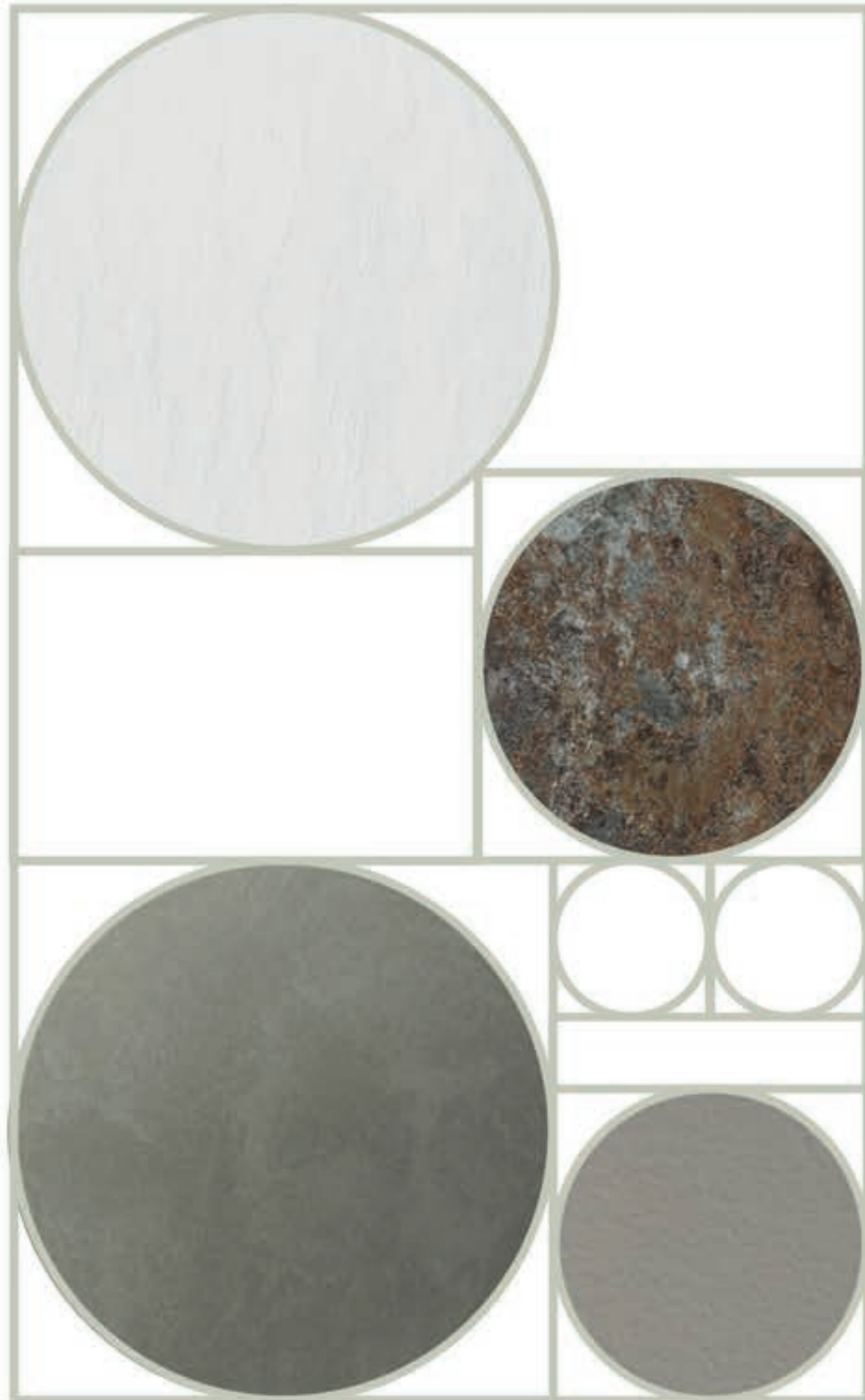

Paneles de revestimiento • Pannelli rivestimento Panneaux de revêtement • Cladding panels

Los paneles Aurea son la opción perfecta para quienes buscan espacios continuos en los que el plato de ducha y el área de su alrededor están revestidos con el mismo material. Los paneles disponibles en los acabados Pizarra, Stone y Liso y en todos nuestros colores estándar aportan versatilidad y enriquecen el diseño del cuarto de baño.

I pannelli Aurea sono una perfetta opzione per chi cerca spazi continui, dove il piatto doccia e le pareti del suo intorno sono rivestiti con lo stesso materiale. I pannelli sono disponibili nelle finiture Ardesia, Stone e Stucco e in tutti i nostri colori standard, apportano versatilità e arricchiscono il disegno del bagno.

Les panneaux Aurea sont le choix idéal pour ceux qui recherchent des espaces continus où le receveur de douche et la zone environnante sont revêtus du même matériau. Les panneaux disponibles dans les finitions Ardoise, Pierre et Stucco et dans toutes nos couleurs standard apportent de la polyvalence et enrichissent le design de la salle de bains.

Aurea panels are the perfect choice for those looking for continuous spaces in which the shower tray and the area around it are cladded with the same material. The panels available in the finishes Slate, Stone and Stucco and in all our standard colors provide versatility and enhance the design of the bathroom.



Paneles de revestimiento
Pannelli da rivestimento
Panneaux de revêtement
Cladding panels

Plato ducha Materia con panel de revestimiento textura Stone color Alba • Piatto doccia Materia con pannello rivestimento finitura Stone colore Alba • Receveur de douche Materia avec panneau de revêtement texture Stone couleur Alba • Shower tray Materia with cladding panel Stone texture in Alba color



Plato ducha Stucco con panel de revestimiento textura Stucco color Cemento • Piatto doccia Stucco con pannello rivestimento finitura Stucco colore Cemento • Receveur de douche Stucco avec panneau de revêtement texture Stucco couleur Cemento • Shower tray Stucco with cladding panel Stucco texture in Cemento color



Plato ducha Cover con panel de revestimiento textura Pizarra y lavabo Tasos color blanco Neve
 Piatto doccia Cover con pannello rivestimento finitura Ardesia e lavabo Tasos color bianco Neve
 Receveur de douche Cover avec panneau de revêtement en texture Ardoise avec lavabo Tasos couleur blanc Neve
 Shower tray Cover with a wall cladding panel in a Slate texture and washbasin Tasos in white Neve color



Perfil intermedio
 Profilo intermedio
 Profil intermédiaire
 Intermediate profile



Perfil final
 Profilo finale
 Profil de finition
 Final profile



Perfil de esquina
 Profilo spigolo
 Profil d'angle
 Corner profile

Encimeras
Top
Plans de toilette
Countertops



Solid Coat

Samos

La serie de Encimeras Samos en SolidCoat nace para ofrecer un amplísimo abanico de posibilidades que permite la consecución del lavabo deseado para cada espacio. Partiendo de las dimensiones de encimera necesarias, se pueden seleccionar 4 medidas de senos diferentes, así como su ubicación en la encimera. Esta serie ofrece también la posibilidad de seleccionar complementos con los que equipar la encimera, como faldones o toallero.

La serie del Top Samos in Solid Coat, è stata creata per offrire un'ampia gamma di possibilità che consentono di ottenere il lavabo desiderato per ogni spazio. Partendo dalle dimensioni del Top, è possibile selezionare 4 diverse dimensioni di vasche, nonché la loro posizione sul piano d'appoggio. Questa serie offre anche la possibilità di scegliere i complementi con cui equipaggiare il Top, come scatolato o portasciugamani.

La série de Plans de toilette Samos en Solid Coat, a été créée pour offrir un large éventail de possibilités, permettant de trouver le lavabo souhaité pour chaque espace. En partant des dimensions du plan de toilette, il est possible de sélectionner 4 tailles différentes de vasques, ainsi que leur position sur le plan de toilette. Cette série offre également la possibilité de choisir les accessoires avec lesquels équiper le plan de toilette, comme une jupe, ou porte-serviettes.

The Samos series of Countertop in Solid Coat, was created to offer a wide range of possibilities, allowing the desired washbasin for every space. Starting with the dimensions of the countertop, 4 different sizes of basins can be selected, as well as their position on the countertop. This series also offers the possibility of choosing the accessories to equip the Countertop with, such as a skirt or towel rails.



	60	70	80	90	100	110	120	130	140	150
46	●	●	●	●	●	●	●	●	●	●
51	●	●	●	●	●	●	●	●	●	●

● Doble seno opcional - Possibilità doppia vasca - Possibilità de double vasque - double basin option



Encimera Samos con faldones en Solid Coat blanco Neve con toallero y cajonera blanca • Top Samos scatolato in Solid Coat bianco Neve con portasciugamani e cassettiera bianca • Plan de toilette Samos avec jupe en Solid Coat blanc Neve, avec porte-serviette et tiroir blanc • Samos Countertop with skirt in Solid Coat white Neve with towel-rail and white drawer unit



Encimera doble seno Samos color Argilla y cajonera blanca
Top doppia vasca Samos colore Argilla e cassettera bianca
Plan de Toilette double vasque Samos en couleur Argilla et meuble à tiroirs en blanc
Countertop Samos with double basin in Argilla color and white drawer unit



Encimera Samos espesor 1,5 cm con seno 45 x 30 x 10h cm • Top Samos da 1,5 cm e vasca da 45 x 30 x 10h cm
 Plan de Toilette Samos épaisseur 1,5 cm avec vasque 45 x 30 x 10h cm • Countertop Samos thickness 1,5 cm with basin 45 x 30 x 10h cm



Encimera Samos con faldones h12 con seno 75 x 30 x 10h cm y cajonera • Top Samos inscatolato h12 con vasca da 75 x 30 x 10h cm e cassetiera
 Plan de toilette Samos avec jupe h12 cm avec vasque 75 x 30 x 10h cm et tiroir • Countertop Samos h12 cm with basin 75 x 30 x 10h cm and drawer

Seno 45 x 30 x 10h cm
 Vasca 45 x 30 x 10h cm
 Vasque 45 x 30 x 10h cm
 Basin 45 x 30 x 10h cm



Seno 60 x 30 x 10h cm
 Vasca 60 x 30 x 10h cm
 Vasque 60 x 30 x 10h cm
 Basin 60 x 30 x 10h cm



Seno 75 x 30 x 10h cm
 Vasca 75 x 30 x 10h cm
 Vasque 75 x 30 x 10h cm
 Basin 75 x 30 x 10h cm



Seno 100 x 30 x 10h cm
 Vasca 100 x 30 x 10h cm
 Vasque 100 x 30 x 10h cm
 Basin 100 x 30 x 10h cm



Cos

Cos forma parte de la línea de lavabos sobre encimera Aurea Bath. Fabricado en Solid Coat blanco mate con acabado liso, permite la personalización en los 12 colores estándar en NitraGel®.

Cos fa parte della linea di lavabi d'appoggio di Aurea Bath. Fabricato in Solid Coat bianco opaco con finitura liscia permette la personalizzazione nei 12 colori standard in NitraGel®.

Cos fait partie de la gamme de vasques à poser Aurea Bath. Fabriqué en Solid Coat blanche opaque avec une finition lisse, il permet une personnalisation dans les 12 couleurs standard en NitraGel®.

Cos is part of the Aurea Bath line of on-top basins. Manufactured in mat white Solid Coat with a smooth finish, it allows customisation in the 12 standard colors in NitraGel®.





Hidra

El modelo de lavabos Hidra de la línea en Solid Coat blanco mate, está disponible en diferentes tamaños y puede satisfacer las necesidades de cualquier espacio y gusto. También en este caso es posible la personalización en los 12 colores estándar Nitragel®.

Il modello di lavabi Hidra della linea in Solid Coat bianco opaco, sono disponibili in diverse dimensioni e consentono di rispondere alle esigenze di qualsiasi spazio e gusto. Anche in questo caso è possibile la personalizzazione delle pareti esterne nei 12 colori standard Nitragel®.

Le modèle Hidra de la ligne de lavabos en Solid Coat blanc mat, est disponible en différentes tailles et peut répondre aux besoins de chaque espace et de chaque goût. Ici aussi, la personnalisation est possible dans les 12 couleurs standard Nitragel®.

The Hidra model of the washbasins line, made of matt white Solid Coat, is available in different sizes and can satisfy the needs of any space and taste. Also in this case, customisation is possible in the 12 standard colours Nitragel®.





Milos

Diseño funcional que busca el confort. Esta premisa de Aurrea vuelve a visibilizarse en MILOS, la nueva colección de lavabos exentos de formato circular. Tiene la medida de 40 x 90 h, fabricado en Solid Coat color Blanco en la versión Mate.

Design funzionale che ricerca il confort. Questa premessa di Aurrea è ancora una volta visibile in MILOS, la nuova collezione di lavabi freestanding in formato circolare, misura 40 x 90 h, confezionato in Solid Coat Bianco nella versione Opaca.

Un design fonctionnel qui recherche le confort. Cette prémisses d'Aurrea est à nouveau visible dans MILOS, la nouvelle collection de lavabos sur pied. En format circulaire, il mesure 40x90 h, fabriqué en Solid Coat, en couleur Blanc, en version Mate.

Functional design seeking out comfort. This Aurrea's premise is once again visible in MILOS, the new collection of freestanding washbasins. With a circular format, it measures 40x90 h, manufactured in Solid Coat, White color in Matte.



Tasos

Como ocurre con su gemelo Milos, TASOS es la apuesta 'minimalista', Mediterránea y 'actual' de Aurea para perfilar esos ambientes únicos y exclusivos en el mundo del baño, y proporcionar un diseño limpio y lineal que evoca vanguardia y singularidad.

Come per il gemello Milos, TASOS è la scommessa 'minimalista', mediterranea e moderna di Aurea per definire quegli ambienti unici ed esclusivi nel mondo del bagno e fornire un design pulito e lineare che evoca avanguardia e unicità.

À l'instar de son jumeau Milos, TASOS est l'approche "minimaliste", Méditerranéenne et "moderne" d'Aurea pour façonner ces ambiances uniques et exclusives dans le monde de la salle de bain, et fournir un design épuré et linéaire qui évoque l'avant-garde et l'unicité.

As with its twin Milos, TASOS is Aurea's "minimalist", Mediterranean and modern bet to outline those unique and exclusive environments in the bathroom world, and provide a clean and linear design evoking avant-garde and uniqueness.



Lavabo Tasos y bañera Santorini bicolor Blanco y Alba

Lavabo Tasos e vasca da bagno Santorini bicolore Bianco e Alba

Lavabo Tasos Alba et baignoire Santorini bi-couleur Blanc-Alba

Washbasin Tasos and bathtub Santorini bi-color White-Alba

Cajoneras
Cassettiere
Tiroirs
Drawers



Santorini Mate

La bañera SANTORINI en Blanco Mate fabricada en Solid Coat consigue que los espacios se vuelvan más dulces y tranquilos gracias a sus sinuosas líneas redondeadas. Disponible en las medidas 150x75 cm y 170 x 80 cm.

La vasca SANTORINI in Blanco Opaco fabricata in Solid Coat consente che l'ambiente si presenti più dolce e tranquillo grazie alle sue linee arrotondate. Disponibile nelle misure 150 x 75 cm e 170 x 80 cm.

La baignoire SANTORINI en Blanc Mat, fabriquée en Solid Coat rend les espaces plus doux et plus calmes grâce à ses lignes sinuées et arrondies. Disponible dans les tailles 150x75 cm et 170x80 cm.

The SANTORINI bathtub in Matt White of Solid Coat makes spaces become more pleasant thanks to its sinuous rounded lines. Available in size 150 x 75 cm and 170 x 80 cm.





Plato doccia Stucco Project, bañera Santorini, lavabo Hidra color Argilla y cajonera Blanca

Platts doccia Stucco Project, vasca Santorini, lavabo Hidra colore Argilla e cassettera Bianca

Receveur de douche Stucco Project avec baignoire Santorini et lavabo Hidra en couleur Argilla et tiroirs en couleur Blanc

Shower tray Stucco Project, bathtub Santorini and washbasin Hidra in Argilla color, with white drawer unit.

Santorini Brillant

Las bañeras exentas son tendencia y ¡no nos extraña! Se convierten en auténticas protagonistas, transformando tu cuarto de baño en un genuino refugio de paz y relajación. Así nos lo muestra la bañera SANTORINI en Solid Coat en Blanco Brillante, en las medidas 150x75 cm y 170x80.

Le vasche Freestanding sono di tendenza non è una sorpresa! Diventano vere protagoniste, trasformando il tuo bagno in una vera oasi di pace e relax. Così come la vasca da bagno Santorini in Solid Coat Bianco lucido, nelle misure 150x75 cm-170x80.

Les baignoires en îlot sont tendance et ce n'est pas étonnant! Elles deviennent de véritables protagonistes en transformant votre salle de bains en un véritable havre de paix et de détente, tout comme le montre la baignoire SANTORINI en Solid Coat en couleur Blanc Brillant, disponible dans les dimensions 150x75 cm et 170x80 cm.

Freestanding bathtubs are trendy and no wonder! They become great protagonists, transforming your bathroom into a true haven of peace and relaxation, as show by the SANTORINI bathtub in Solid Coat in Gloss White color, available in sizes 150x75 cm and 170x80 cm.



CORIAN®
DESIGN



Naxos

Naxos, bañera exenta, fabricada en Corian[®], color Blanco, disponible en las medidas de 155 x 75 x 50h y 170 x 80 x 50 h cm, con la posibilidad de colorear la parte exterior en nuestros 12 colores estándar en Nitragel[®]

Naxos, vasca da bagno, free standing, fabbricata in Corian[®], in colore Bianco disponibile nelle misure 155x75x50h e 170x80x50h cm, con la possibilità di colorare la parte esterna con i nostri 12 colori standard Nitragel[®]

Naxos, baignoire en îlot, fabriquée en Corian[®], couleur Blanc, disponible dans les dimensions 155 x 75 x 50h et 170 x 80 x 50h cm, avec la possibilité de colorer la face extérieure avec nos 12 couleurs standard en Nitragel[®].

Naxos, freestanding bathtub made in Corian[®], White color, available in sizes 155 x 75 x 50h, and 170 x 80 x 50h cm, with the possibility of coloring the outer face with our 12 standard colors in Nitragel[®]



CORIAN[®]
DESIGN



CORIAN[®]
DESIGN

Siros

Bañera exenta a pared, fabricada en Corian®, color Blanco, disponible en la medida de 170 x 86 x 50h cm, con la posibilidad de colorear la parte exterior en nuestros 12 colores estándar en Nitragel®.

Vasca freestanding a parete, fabbricata in Corian®, in colore Bianco disponibile nella misura 170 x 86 x 50h cm, con la possibilità di colorare la parte esterna nei nostri 12 colori standard Nitragel®.

Baignoire flot murale, fabriquée en Corian®, couleur Blanc, disponible au format de 170 x 86 x 50h cm avec la possibilité de colorer la face extérieure avec nos 12 couleurs standard en Nitragel®.

Freestanding back to wall bathtub; made in Corian®, White color, available in the size 170 x 86 x 50h cm with the possibility of coloring the outer face with our 12 standard colors in Nitragel®.



Chios

Bañera de diseño sencillo y moderno, fabricada en Corian Blanco, en las medidas 150x75x53h, 160x80x53h y 170x80x53h cm, con la posibilidad de colorear la cara exterior en nuestros 12 colores estándar en Nitragel®

Vasca semplice con un design moderno, fabricata in Corian, in colore Bianco disponibile nelle misure 150 x 75 x 53h, 160 x 80 x 53h, 170 x 80 x 53h cm, con la possibilità di colorare la parte esterna nei nostri 12 colori standard Nitragel®.

Baignoire au design simple et moderne, fabriquée en Corian, couleur Blanc, disponible aux formats de 150 x 75 x 53h, 160 x 80 x 53h et 170 x 80 x 53h cm, avec la possibilité de colorer la face extérieure avec nos 12 couleurs standard en Nitragel®.

Bathitub with a simple and modern design, made in Corian, White color, available in the sizes 150x75x53h, 160x80x53h and 170x80x53h, with the possibility of coloring the outer face with our 12 standard colors in Nitragel®



Itaca

Es el modelo más grande de nuestra colección de bañeras en Corian® Blanco, disponible en la medida 180 x 85 x 51h cm, con la posibilidad de colorear la cara exterior en nuestros 12 colores estándar en Nitragel®.

È la vasca da bagno più grande della nostra collezione freestanding, fabbricate in Corian® Bianco, nella misura 180 x 85 x 51h cm con la possibilità di colorare la parte esterna nei nostri 12 colori standard Nitragel®.

C'est le plus grand modèle de notre collection de baignoires en Corian® Blanc, disponible au format de 180 x 85 x 51h cm, avec la possibilité de colorer la face extérieure avec nos 12 couleurs standard en Nitragel®.

It is the largest model of our collection of bathtubs in Corian® White, available in the size 180 x 85 x 51h cm with the possibility of coloring the outer face with our 12 standard colors in Nitragel®.



Symi

De diseño arquitectónico, sugiere sin imponer vínculos formales, colocando siempre la bañera en el foco de atención. Fabricada en Corian de color blanco en la medida 80 x 180x 63h con la posibilidad de colorear la cara exterior con nuestros 12 colores estándar en Nitragel®

Progettata architettonicamente, suggerisce senza imporre legami formali, ponendo sempre la vasca da bagno al centro dell'attenzione. Realizzato in Corian bianco nelle dimensioni 80 x 180x 63h con la possibilità di colorare la superficie esterna con i nostri 12 colori standard in Nitragel®.

De conception architecturale, elle suggère sans imposer des liens formels, en plaçant toujours la baignoire au centre de l'attention. Fabriquée en Corian blanc dans les dimensions 80 x 180x 63h avec la possibilité de colorer la face extérieure avec nos 12 couleurs standard en Nitragel®.

Architecturally designed, it suggests without imposing formal links, always placing the bathtub in the spotlight. Made of white Corian in size 80 x 180x 63h with the possibility of coloring the outer face with our 12 standard colors in Nitragel®



Delos H 7

Delos H 7, lavabos semi-encastados. De nuestra colección de lavabos fabricados en Corian Blanco en las medidas 38 x 38; 50 x 38; 62 x 38, con la posibilidad de colorear la cara externa con nuestros 12 colores estándar.

Delos H 15, lavabi semi incastro. Dalla nostra collezione di lavabi realizzati in Corian Bianco nelle misure 38 x 38; 50 x 38; 62 x 38 cm, con la possibilità di colorare la parte esterna con i nostri 12 colori standard.

Delos H 7, lavabos semi-encastrés. De notre collection de lavabos fabriqués en Corian Blanc, aux dimensions 38 x 38; 50 x 38; 62 x 38 cm, avec la possibilité de colorer la face externe avec nos 12 couleurs standard.

Delos H 7, semi-recessed washbasins. From our collection of washbasins made of Corian White in sizes 38 x 38; 50 x 38; 62 x 38 cm, with the possibility of coloring the outer face with our 12 standard colors.



Delos H 15

Delos H 15, lavabos sobre encimera. De nuestra colección de lavabos fabricados en Corian Blanco, en las medidas 38 x 38; 50 x 38 cm; 62 x 38, con la posibilidad de colorear la cara externa con nuestros 12 colores estándar.

Delos H 15, lavabi soprapiano. Dalla nostra collezione di lavabi realizzati in Corian Bianco nelle misure 38 x 38; 50 x 38; 62 x 38 cm, con la possibilità di colorare la parte esterna con i nostri 12 colori standard.

Delos H 15, lavabos sur plan de toilette. De notre collection de lavabos fabriqués en Corian Blanc aux dimensions 38 x 38 ; 50 x 38 ; 62 x 38 cm, avec la possibilité de colorer la face externe avec nos 12 couleurs standard.

Delos H 15, on top washbasins. From our collection of washbasins made of Corian White in sizes 38 x 38; 50 x 38; 62 x 38 cm, with the possibility of coloring the outer face with our 12 standard colors.



Andros

La colección Andros fabricada en Corian Blanco es un guiño al diseño en lavabos de última generación, disponibles en las medidas 50 x 50 x 16 y 65 x 50 x 16 cm.

La collezione Andros fabricata in Corian Bianco si ispira al design dei lavabi di ultima generazione, disponibili nelle dimensioni 50 x 50 x 16 e 65 x 50 x 16.

La collection Andros fabriquée en Corian Blanc est un clin d'oeil au design des lavabos de pointe, disponibles dans les dimensions 50 x 50 x 16 et 65 x 50 x 16 cm.

The Andros collection made of Corian White is a nod to the design of state-of-the-art washbasins, available in the sizes 50 x 50 x 16 and 65 x 50 x 16 cm.



Eubea

La colección de lavabos Eubea destaca por sus formas geométricas clásicas, con los espesores ultrafinos de última tendencia. Fabricados en Corian Blanco, disponibles en las siguientes medidas: rectangular 36x36x11 y 59x39x11; oval 57x36x11, y redondo Ø 39 x11

La collezione di lavabi Eubea si distingue per le sue forme geometriche classiche, con l'ultima tendenza degli spessori ultrasottili. Prodotto in Corian Bianco, disponibile nelle seguenti misure: rettangolare 36 x 36 x 11 e 59 x 39 x 11; ovale 57 x 36 x 11 e rotondo Ø 39 x 11 cm.

La collection de lavabos Eubea se distingue par ses formes géométriques classiques, avec la dernière tendance en matière d'épaisseurs ultrafines. Fabriqués en Corian Blanc, disponibles dans les formats suivants: rectangulaires 36 x 36 x 11 et 59 x 39 x 11; ovale 57 x 36 x 11 et rond Ø 39 x 11 cm.

The Eubea washbasins collection stands out for its classic geometric shapes, with the latest trend of ultra-thin thicknesses. Manufactured in Corian White, available in following measures: rectangular 36 x 36 x 11 and 59 x 39 x 11; oval 57 x 36 x 11 and round Ø 39 x 11 cm.

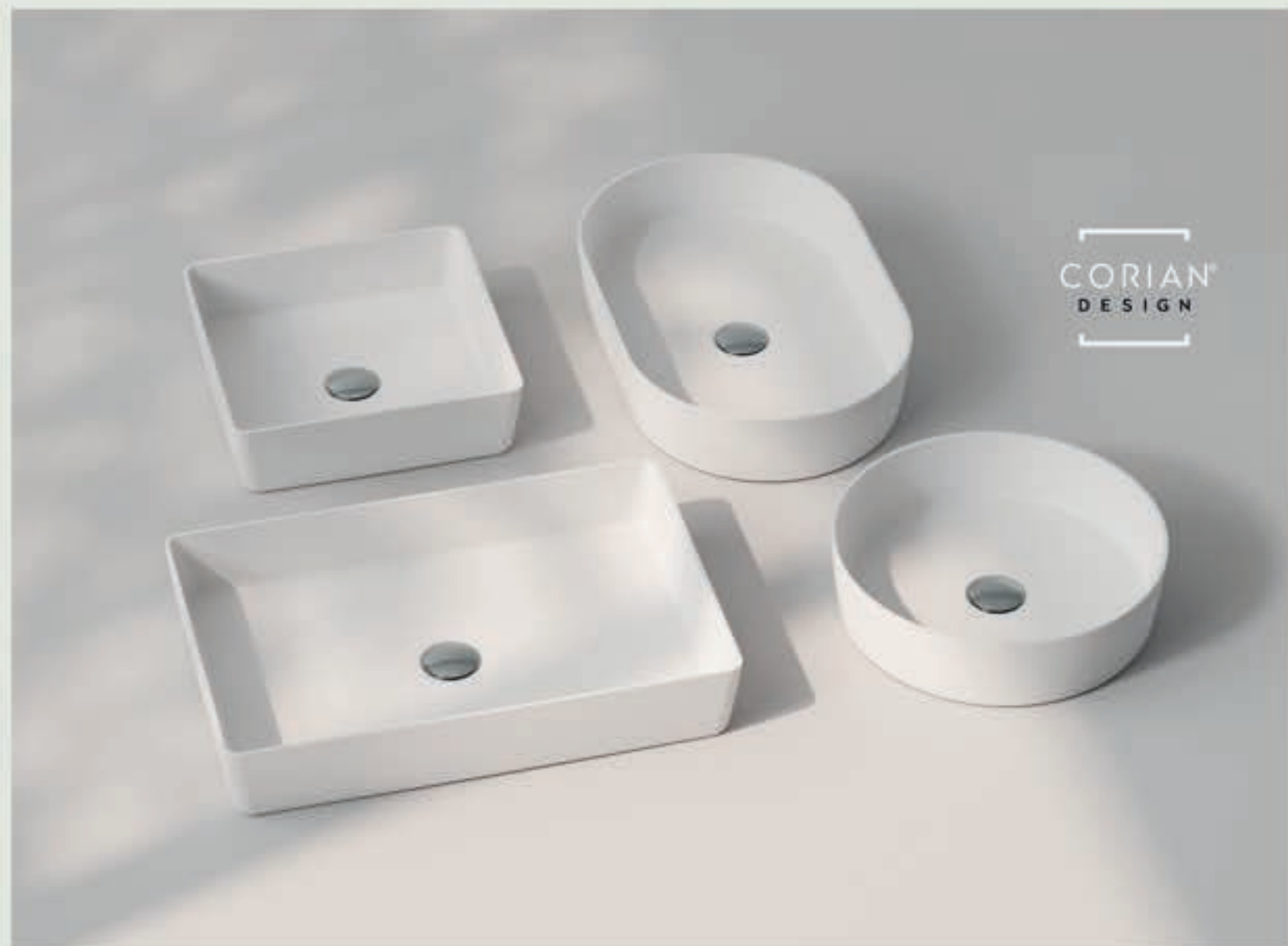



AUREA
• DEKO •





En los últimos años, el baño se ha consolidado como un centro social en el hogar, mostrando la tendencia a diseñar baños espaciosos y confortables a través de elementos que marcan un estilo y un estatus: muebles, mamparas, platos de ducha. Nuestro estilo de vida actual está indudablemente ligado al desarrollo sostenible y al ahorro energético; por lo que, con el cambio de la bañera al plato de ducha, ganamos espacio y podemos dar un toque de elegancia al baño sin necesidad de costosas reformas. AUREA Deko nace con el objetivo de aportar al sector del baño materiales tecnológicos y estéticos acompañando a los diseñadores de interiores y al cliente final en su recorrido por las tendencias y la inspiración, y ofrecer productos de calidad con infinitas posibilidades de diseño.

Negli ultimi anni il bagno si è consolidato come centro sociale della nostra casa, incoraggiando la tendenza a progettare bagni spaziosi e confortevoli utilizzando elementi con uno stile e uno status distintivi: mobili, schermi, piatti doccia. Lo stile di vita di oggi è indiscutibilmente legato alla sostenibilità e all'efficienza energetica, quindi passare da una vasca da bagno a un piatto doccia, aiuta a guadagnare spazio e dona un tocco di eleganza al bagno senza bisogno di costosi lavori di ristrutturazione. AUREA Deko nasce con l'obiettivo di fornire al settore bagno materiali ad alta tecnologia, innovativi ed estetici, supportare interior designer e clienti finali nel loro viaggio attraverso tendenze e ispirazioni e offrire prodotti di alta qualità con infinite potenzialità di design.

Au cours des dernières années, la salle de bain s'est imposée comme un centre social dans la maison, affichant la tendance à concevoir des salles de bains spacieuses et confortables à travers des éléments qui marquent un style et un statut : meubles, pare-douches, receveurs. Notre style de vie actuel est incontestablement lié au développement durable et à l'économie énergétique ; c'est pourquoi, avec le passage de la baignoire au receveur de douche, on gagne de l'espace et nous pouvons donner une touche d'élégance à la salle de bain sans rénovation coûteuse. AUREA Deko est née dans le but d'apporter au secteur de la salle de bain des matériaux technologiques et esthétiques pour accompagner les décorateurs d'intérieur et le client final dans leur parcours au sein des tendances et de l'inspiration, et de proposer des produits de qualité présentant des possibilités infinies de design.

Over the last few years, the bathroom has consolidated itself as a social center in homes, encouraging the trend of designing spacious and comfortable bathrooms using elements with a distinctive style and status: furniture, screens, shower trays. Today's lifestyle is unquestionably linked to sustainability and energy efficiency, thus switching from a bathtub to a shower tray, helps to gain space and lends a touch of elegance to the bathroom without the need for costly refurbishment. AUREA Deko was founded with the aim of providing the bathroom sector with high-tech, innovative and aesthetic materials, supporting interior designers and end customers in their journey through trends and inspiration, and offering high quality products with endless design potential.

Materia *Baltic*

Con el acabado Baltic nuestro modelo de plato de ducha Materia Deko, se ajusta a las nuevas tendencias del cuarto de baño.

Con la finitura Baltic il nostro modello di piatto doccia Materia Deko, si adatta alle nuove tendenze del bagno.

Avec la finition Baltic, notre modèle de receveur de douche Materia Deko, s'adapte aux dernières tendances des salles de bains.

With the Baltic finish our Materia Deko shower tray model, fits the new trends of the modern bathroom.



Cover *Ossido*

Plato de ducha modelo Cover Deko, en acabado Ossido, el inconfundible tono rojizo del óxido, que aporta calidez a la estancia.

Piatto doccia modello Cover Deko, in finitura Ossido, l'inconfondibile tonalità rossastra del ossido, che conferisce calore all'ambiente.

Receveur de douche modèle Cover Deko, en finition Ossido, l'incomparable teinte rougeâtre de la rouille, qui apporte de la chaleur à la pièce.

Shower tray model Cover Deko, in Ossido finish, the unmistakable reddish shade of rust, which adds warmth to the room.



Calatrava *Statuario*

Plato de ducha Calatrava Deko, en acabado Statuario. Distinguido por sus veteados en tono gris, y la gran blancura de esta majestuosa simulación de mármol en tu baño.

Piatto doccia Calatrava Deko, in finitura Statuario. Si distingue per le sue venature grigie e il grande biancore di questa maestosa simulazione del marmo nel tuo bagno.

Calatrava Deko, en finition Statuario. Se distinguent par son veinage en teinte gris et la grande blancheur de cette majestueuse simulation de marbre dans votre salle de bains.

Calatrava Deko shower tray, in Statuario finish. Distinguished by its gray-tone veining, and the great whiteness of this majestic simulation of marble in your bathroom.



Urban *Brown*

Granito y mármol son materiales siempre presentes en la decoración de interiores, así como en nuestro modelo Urban Deko en acabado Brown.

Granito e marmo sono materiali sempre presenti nella decorazione di interni, così come nel nostro modello Urban Deko, in finitura Brown.

Le granit et le marbre sont des matériaux toujours présents dans la décoration intérieure, ainsi que dans notre modèle Urban Deko en finition Brown.

Granite and marble are materials always present in indoor decoration, as well as in our Urban Deko model in Brown finish.



Nevo *Siena*

Con el plato de ducha Nevo Deko , en acabado Siena imitamos esta elegante piedra negra de vetas blancas.

Con il piatto doccia Nevo Deko , in finitura Siena , imitiamo questa elegante pietra nera venata di bianco.

Avec le receveur de douche Nevo Deko , en finition Siena , nous imitons cette élégante pierre noire à veinures blanches.

With the Nevo Deko shower tray , in Siena finish , we imitate this elegant White-veined black stone.



Essential *Jazz*

Plato de ducha Essential Deko , en acabado Jazz , contribuye a crear ese espacio de baño actual con un toque retro, que nos hará viajar en el tiempo.

Piatto doccia Essential Deko , in finitura Jazz , contribuisce a creare quello spazio bagno contemporaneo dal tocco retrò, che ci farà viaggiare indietro nel tempo.

Le receveur de douche Essential Deko , en finition Jazz , contribue à créer cet espace de salle de bain contemporaine avec une touche retrò, qui nous fera voyager dans le temps.

Shower tray Essential Deko , in Jazz finish , contributes to create that contemporary bathroom space with a retro touch, which will make us travel back in time.



ΑΥΡΕΑ • DEKO •

Encimera Samos con faldón H12, Plato ducha Cover y Cajonera con diseño Deko Liqueur.

Top Samos scatoiato H12, Piatto doccia Cover e Cassettiera Deko finitura Liqueur.

Plan de Toilette Samos avec jupe H12, Receveur de douche Cover et Tiroir avec dessin Deko Liqueur.

Samos Countertop with skirt H12, Cover shower tray and drawer in Liqueur Deko design.



AUREA
• DEKO •
COLLECTIONS



TILES



AUREA
• DEKO •



ARABIC



QURQA
•DEKO•



TRIANGLE



QURQA
•DEKO•



STYLE

ACANTO



QUREA
• DEKO •



STYLE

JAZZ

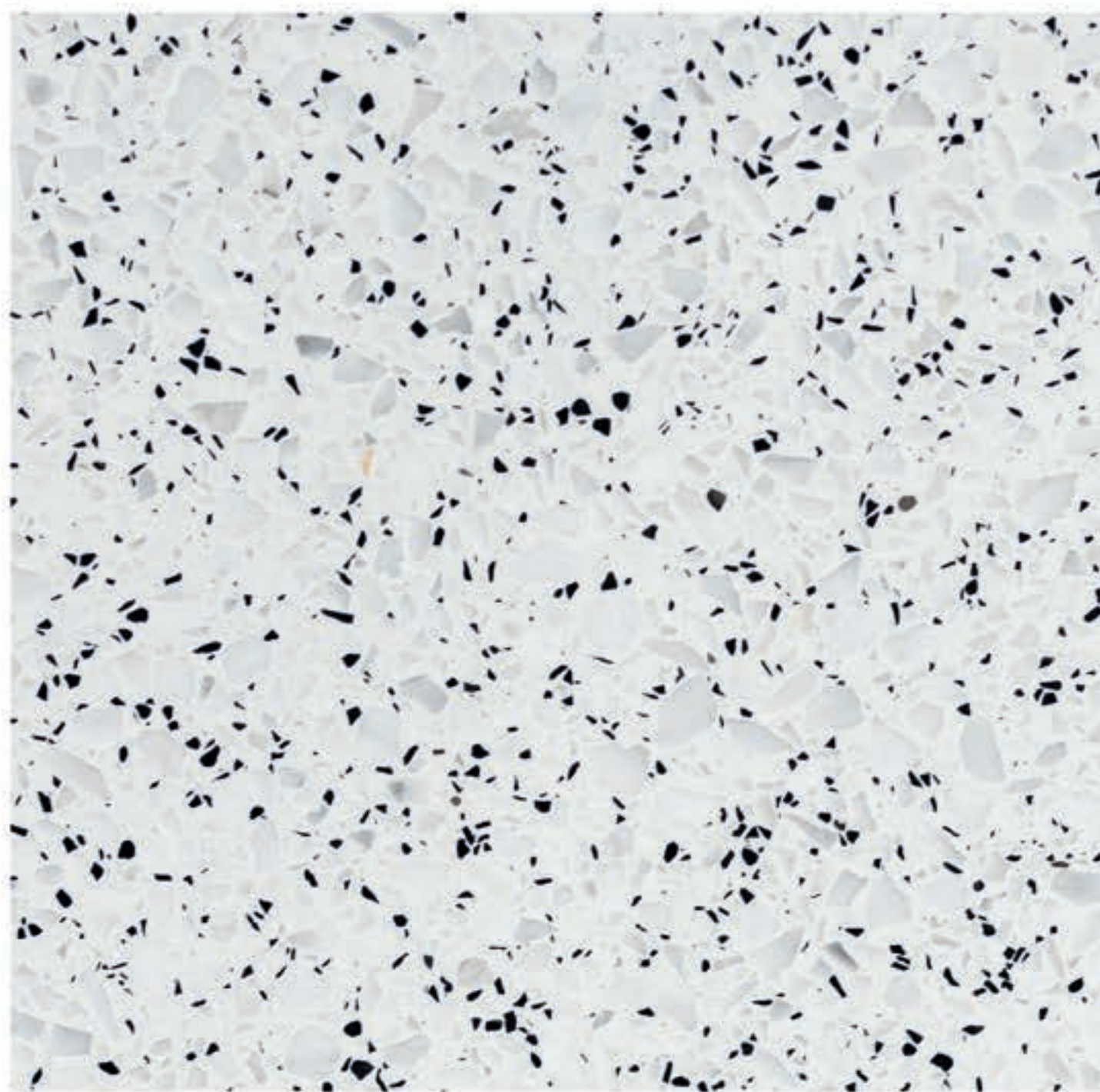

QUREA
• DEKO •

AUREA
• DEKO •
COLLECTIONS



INDUSTRIAL

LIQUEN



AUREA
• DEKO •



INDUSTRIAL

OSSIDO



QURQA
•DEKO•



INDUSTRIAL

LAVA

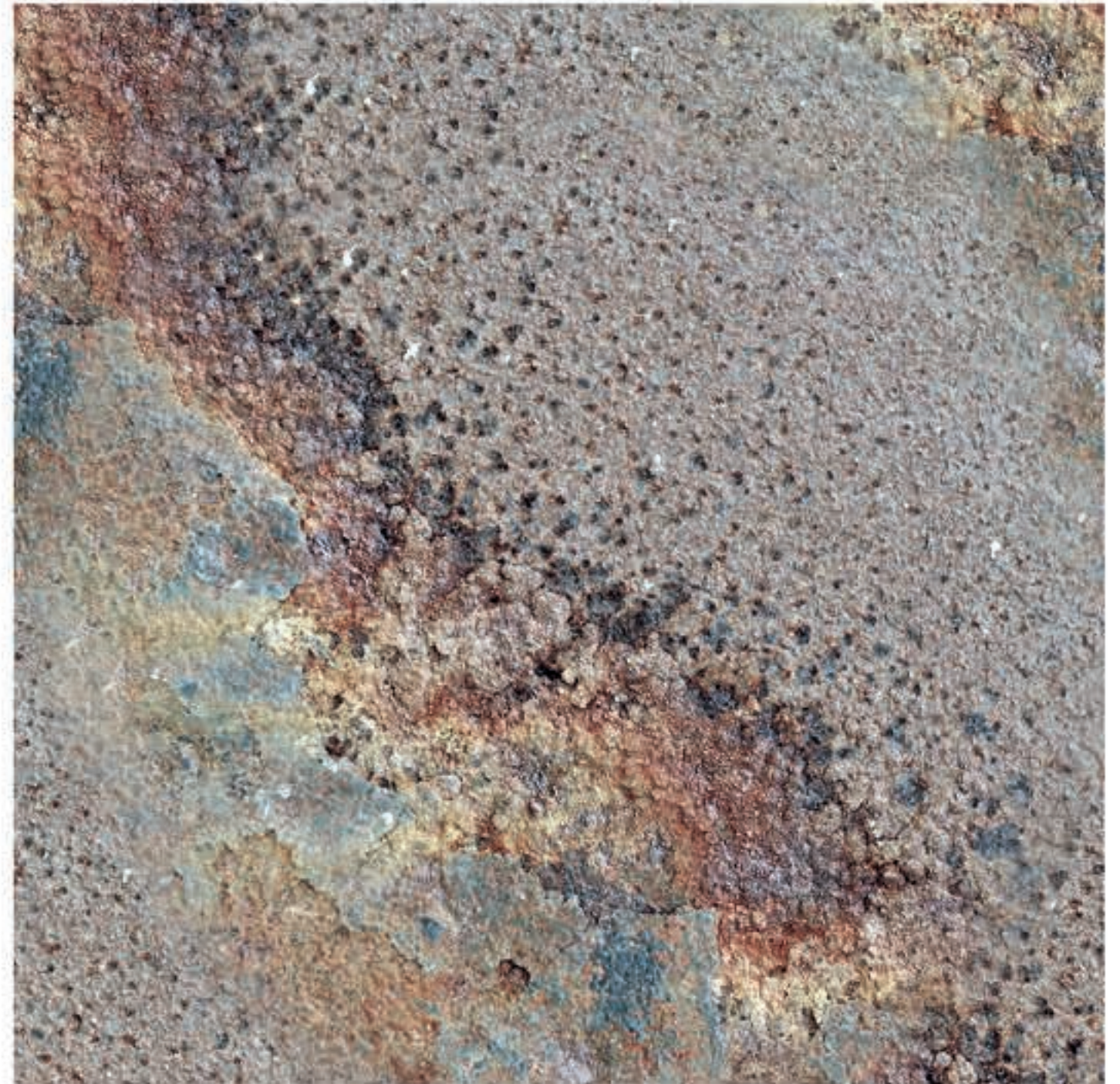

QURQA
•DEKO•



INDUSTRIAL

RUST

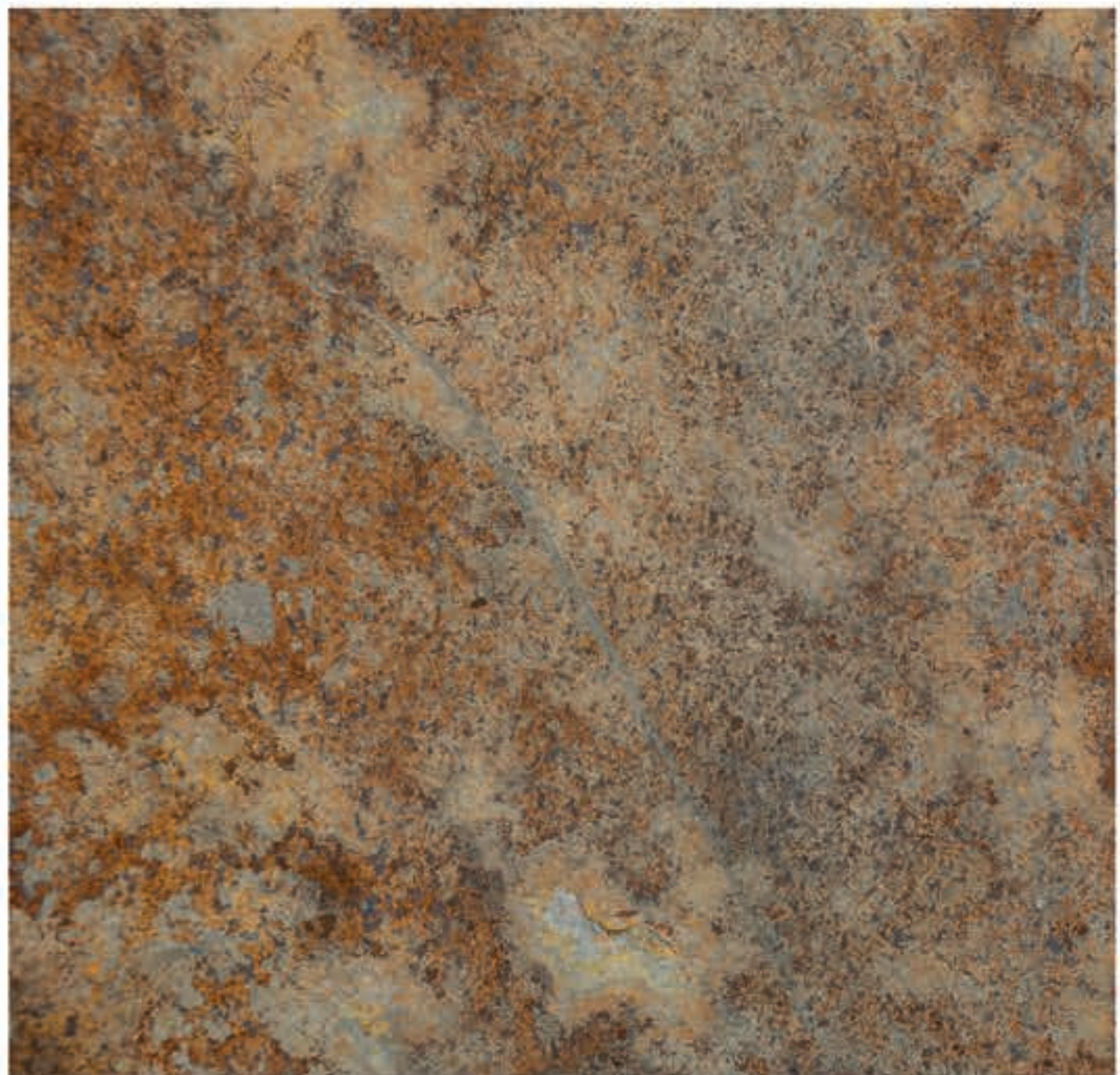

AUREA
• DEKO •



INDUSTRIAL

SUNBURNT

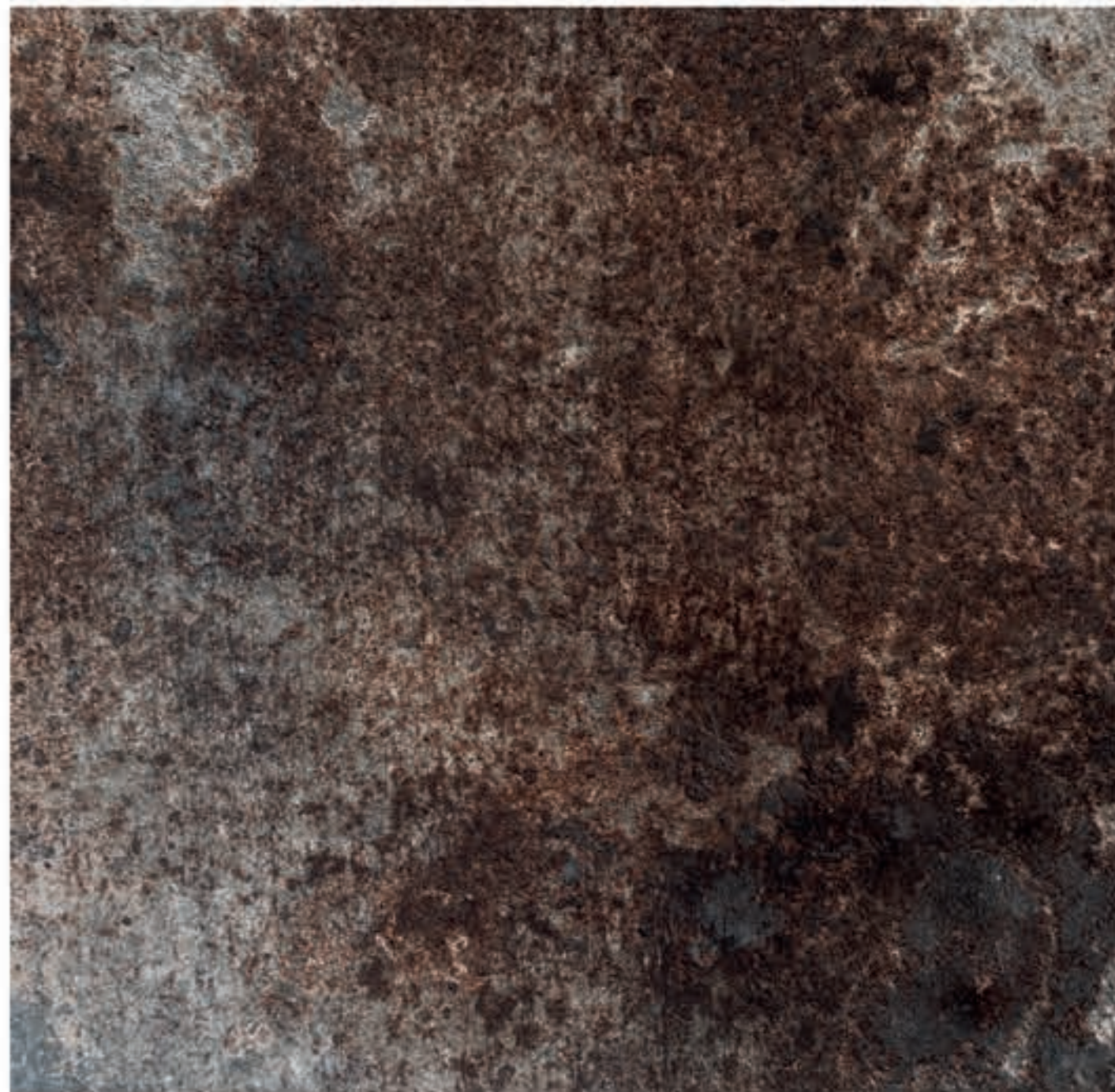

AUREA
• DEKO •

ΑΥΡΕΑ
• DEKO •
COLLECTIONS



NATURE

ONYX



ΑΥΡΕΑ
• DEKO •



NATURE

STATUARIO



AUREA
• DEKO •



NATURE

SIENA

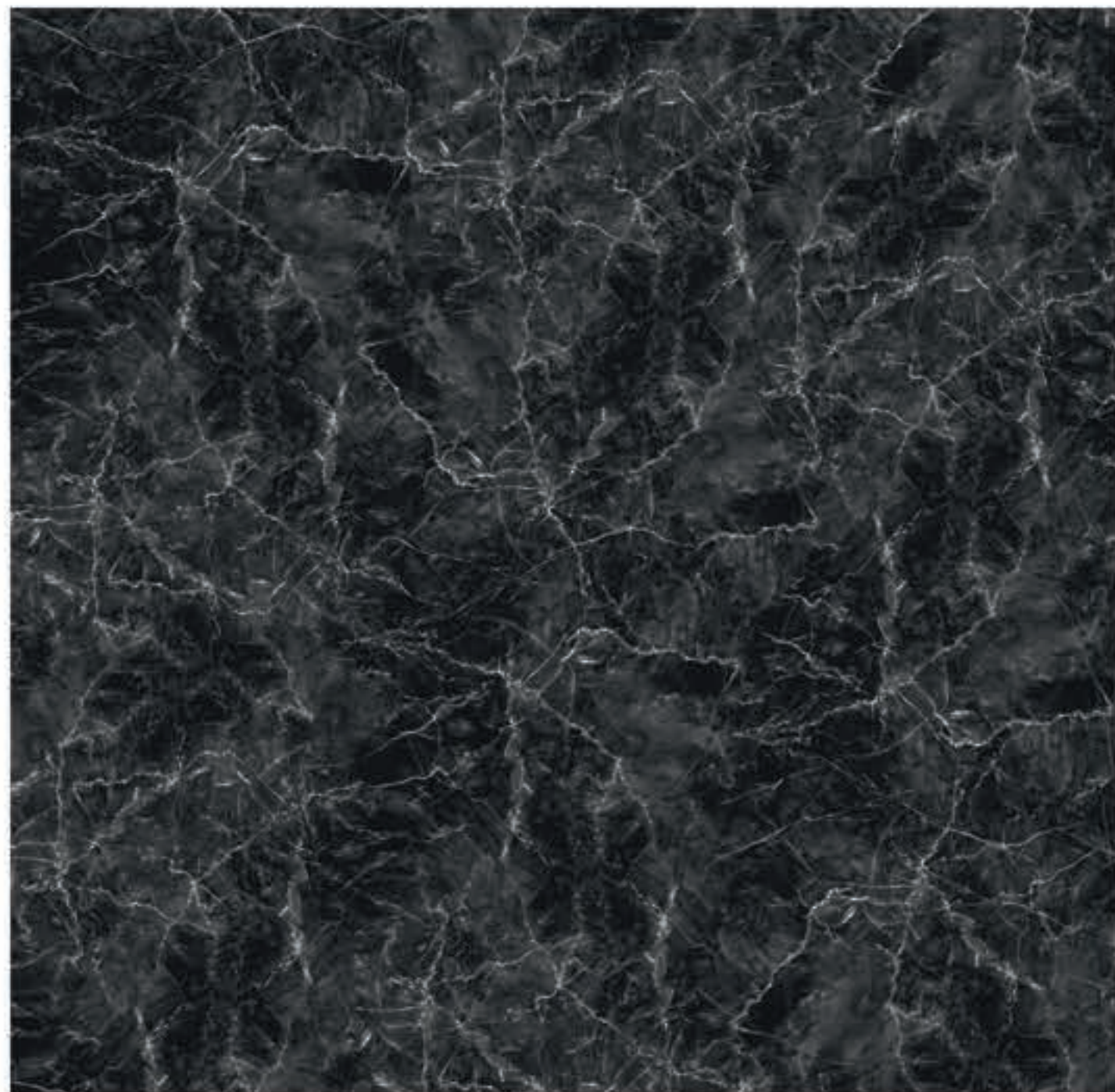

AUREA
• DEKO •



NATURE

BALTIC

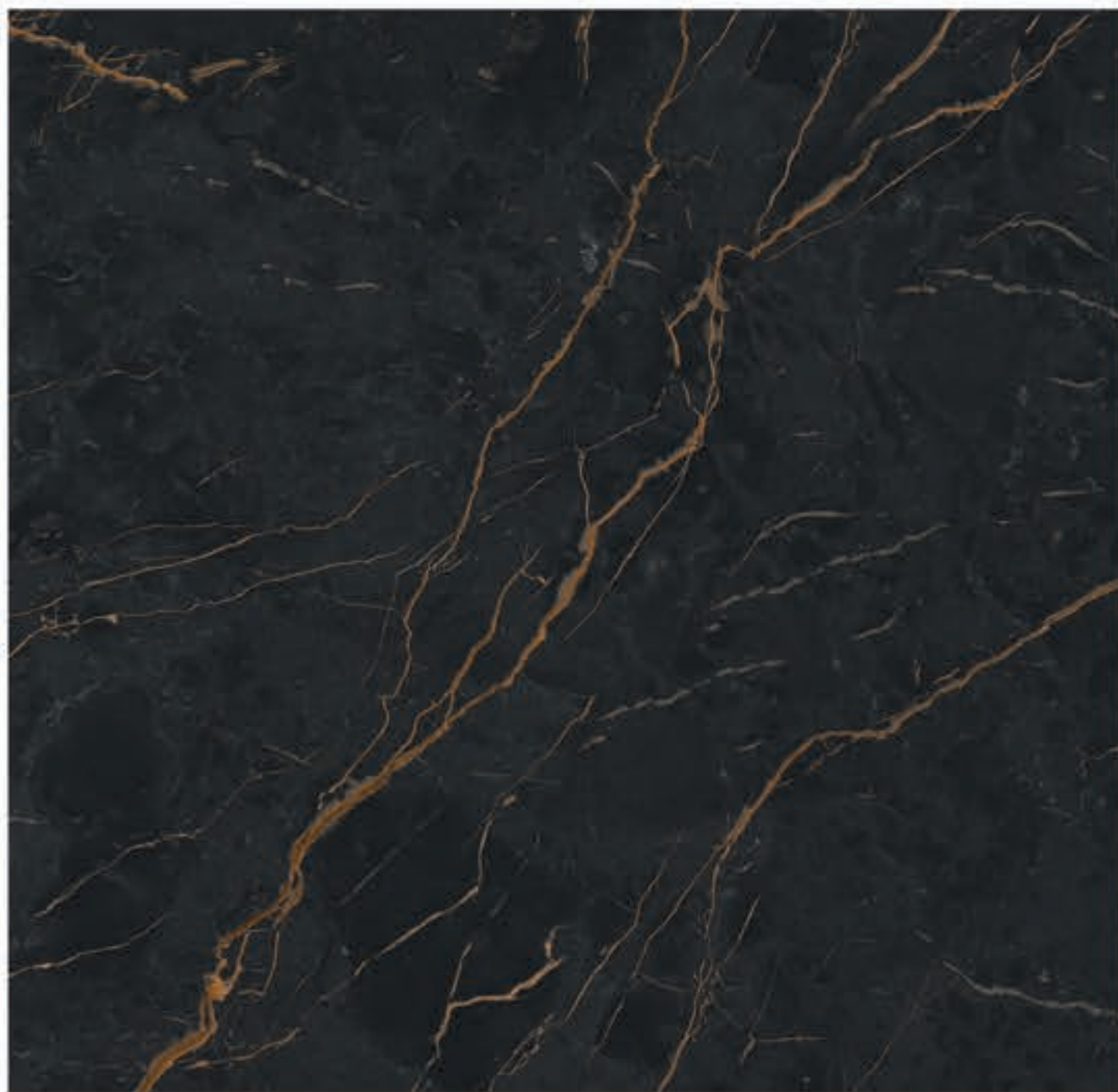

AUREA
• DEKO •



NATURE

BROWN



AUREA
• DEKO •

AUREA
• DEKO •
COLLECTIONS



STONE

ARENARIA



AUREA
• DEKO •



GREY STONE



QURQA
• DEKO •



GREY PEARL



QURQA
• DEKO •



STONE

CEMENT



QUREQ
•DEKO•



STONE

GRUNGE



QUREQ
•DEKO•

AUREA
• DEKO •
COLLECTIONS



ALABASTER



AUREA
• DEKO •



LEGEND



QURQA
• DEKO •



VINTAGE



QURQA
• DEKO •



WOOD

HORIZON



QUREQ
•DEKO•



WOOD

EXOTIC



QUREQ
•DEKO•



Expositores • Espositori
Présentoirs • Displays

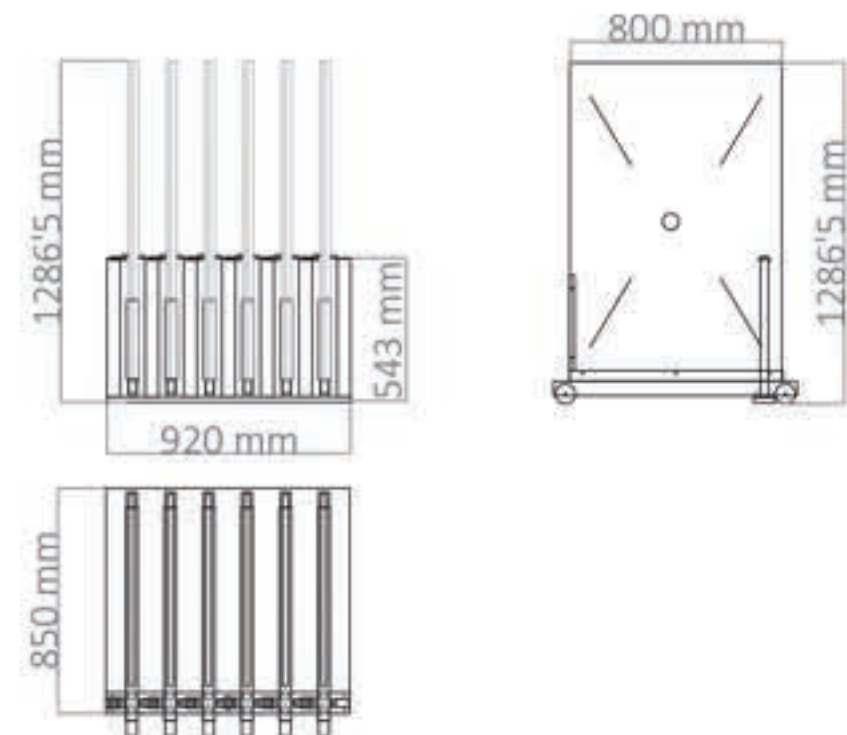

www.aureabath.com

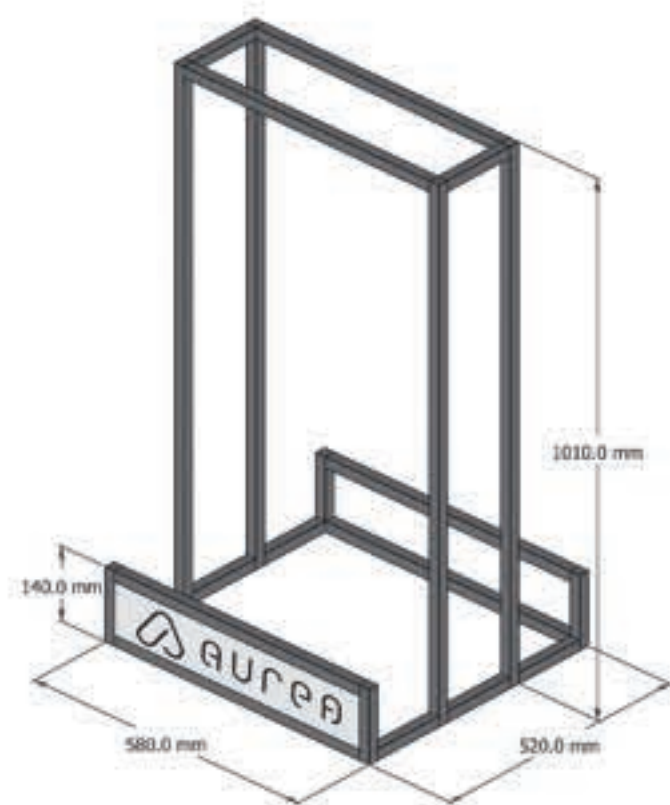
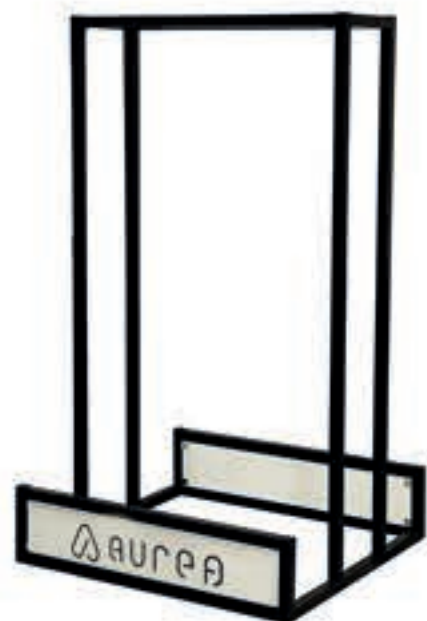

Características • Caratteristiche
Caractéristiques • Features



TEXTURA / FINITURE / TEXTURE / TEXTURE						
		PIZARRA ARDESIA ARDOISE SLATE	STONE	LISO LISCIO LISSE SMOOTH	STUCCO	DEKO
Nitragel		0,6 mm	0,6 mm	0,6 mm	0,6 mm	0,6 mm
MASSA SOLIDA MASSA SOLIDA MASSE SOLIDE SOLID MASS		✓	✓	✓	✓	✓
FACILIDAD DE CORTE FACILITÀ DI TAGLIO FACILE À DÉCOUPER EASY TO CUT		✓	✓	✓	✓	✓
ALTA RESISTENCIA AL DESGASTE ALTA RESISTENZA AL LOGGAMENTO HAUTE RÉSISTANCE À L'USURE WEARING OUT HARD RESISTANCE		RESISTENCIA A LA DECOLORACIÓN POR RAYOS UVA-RESISTENCIA AGENTES QUÍMICOS RESISTENZA AL CAMBIO COLORE PER RAGGI UV-RESISTENZA AGENTI CHIMICI PRÉSERVE DE LA DÉCOLORATION PAR UV-RÉSISTANCE AUX AGENTS CHIMIQUES PRESERVES FROM UV RAYS DECOLOURING-CHEMICAL AGENTS RESISTANCE				
NORMATIVA DESAGÜE CE - UNE EN 274 NORMATIVA SCARICO CE - UNE EN 274 NORMES VIDANGE CE - UNE EN 274 WASTE PIPE REGULATIONS - UNE EN 274		✓	✓	✓	✓	✓
ANTIDESLIZANTE NORMA DIN 51097:1992 NORMA ANTISCIVOLO DIN 51097:1992 NORME ANTIDÉRAPANT DIN 51097:1992 ANTI-SLIP REGULATION DIN 51097:1992		B	A	B	B	B
ANTIDESLIZANTE NORMA UNE-EN 12633 NORMA ANTISCIVOLO UNE-EN 12633 NORME ANTIDÉRAPANT UNE-EN 12633 ANTI-SLIP REGULATION UNE-EN 12633		3	3	2	3	3
KIT DE RÉPARACIÓN KIT DI RIPARAZIONE KIT DE RÉPARATION REPAIR KIT		✓	✓	✓	✓	✓
KIT DE RECUPERACIÓN KIT DI RECUPERO KIT DE RÉCUPÉRATION RECOVERY KIT		✓	✓	✓	✓	
LÍMITE DE TOLERANCIA SOGLIA DI TOLLERANZA SEUIL DE TOLÉRANCE THRESHOLD OF TOLERANCE		0,3%	0,3%	0,3%	0,3%	0,3%

* La collezione DEKO si ripara unicamente con colori solidi. / La collezione DEKO si ripara unicamente con colori solidi. / La collection DEKO peut être réparée uniquement avec des couleurs unies / DEKO-collection can be repaired only with solid colors.

Ensayos de resistencia • Prove di resistenza
Essais de resistance • Resistance tests

PRODUCTO PRODOTTO PRODUIT PRODUCT	TIEMPO DE EXPOSICIÓN TEMPO DI ESPOSIZIONE TEMPS D'EXPOSITION EXPOSURE TIME	RESULTADO RISULTATO RÉSULTAT RESULT	LIMPIEZA PULIZIA NETTOYAGE CLEANING
BETADINE	24 H	RESISTE (Non es afectado) RESISTE (Non è influenzato) RÉSISTE (N' affecte pas) RESISTS (Not affected)	ALCOHOL O ACETONA ALCOOL O ACETONE ALCOHOL OU ACÉTONE ALCOHOL OR ACETONE
AGUARRÁS ACQUARAGIA ESSENCE DE TERÉBENTINE TURPENTINE	24 H	RESISTE (Non es afectado) RESISTE (Non è influenzato) RÉSISTE (N' affecte pas) RESISTS (Not affected)	AGUA Y JABÓN ACQUA E SAPONE EAU ET SAVON WATER AND SOAP
CILUT BANG	24 H	RESISTE (Non es afectado) RESISTE (Non è influenzato) RÉSISTE (N' affecte pas) RESISTS (Not affected)	AGUA Y JABÓN ACQUA E SAPONE EAU ET SAVON WATER AND SOAP
AMONIACO AMMONIACA AMMONIACQUE AMMONIA	24 H	RESISTE (Non es afectado) RESISTE (Non è influenzato) RÉSISTE (N' affecte pas) RESISTS (Not affected)	AGUA Y JABÓN ACQUA E SAPONE EAU ET SAVON WATER AND SOAP
LEJÍA CANDEGNA EAU DE JAVEL BLEACH	24 H	RESISTE (Non es afectado) RESISTE (Non è influenzato) RÉSISTE (N' affecte pas) RESISTS (Not affected)	AGUA Y JABÓN ACQUA E SAPONE EAU ET SAVON WATER AND SOAP
SALFURÁN ACIDO CLORIDRICO ACIDE CHLORHYDRIQUE ACYL CHLORIDE	24 H	RESISTE (Non es afectado) RESISTE (Non è influenzato) RÉSISTE (N' affecte pas) RESISTS (Not affected)	AGUA Y JABÓN ACQUA E SAPONE EAU ET SAVON WATER AND SOAP
DESATASCADOR SODA CAUSTICA SOUDE CAUSTIQUE CAUSTIC SODA	24 H	RESISTE (Non es afectado) RESISTE (Non è influenzato) RÉSISTE (N' affecte pas) RESISTS (Not affected)	AGUA Y JABÓN ACQUA E SAPONE EAU ET SAVON WATER AND SOAP
TINTE DE PELO TINTE PER CAPELLI TEINTURE POUR LES CHEVEUX HAIR COLOR	24 H	RESISTE (Non es afectado) RESISTE (Non è influenzato) RÉSISTE (N' affecte pas) RESISTS (Not affected)	AGUA Y JABÓN ACQUA E SAPONE EAU ET SAVON WATER AND SOAP
VAKAL	24 H	RESISTE (Non es afectado) RESISTE (Non è influenzato) RÉSISTE (N' affecte pas) RESISTS (Not affected)	AGUA Y JABÓN ACQUA E SAPONE EAU ET SAVON WATER AND SOAP
BOTULADOR PERMANENTE PENNARELLO INDELEBILE FEUTRE INDELEBILE PERMANENT MARKER	24 H	RESISTE (Non es afectado) RESISTE (Non è influenzato) RÉSISTE (N' affecte pas) RESISTS (Not affected)	ALCOHOL O ACETONA ALCOOL O ACETONE ALCOHOL OU ACÉTONE ALCOHOL OR ACETONE
VINAGRE ACETO VINAIGRE VINEGAR	24 H	RESISTE (Non es afectado) RESISTE (Non è influenzato) RÉSISTE (N' affecte pas) RESISTS (Not affected)	AGUA Y JABÓN ACQUA E SAPONE EAU ET SAVON WATER AND SOAP

Planos técnicos • Disegni tecnici
Schémas techniques • Technical files

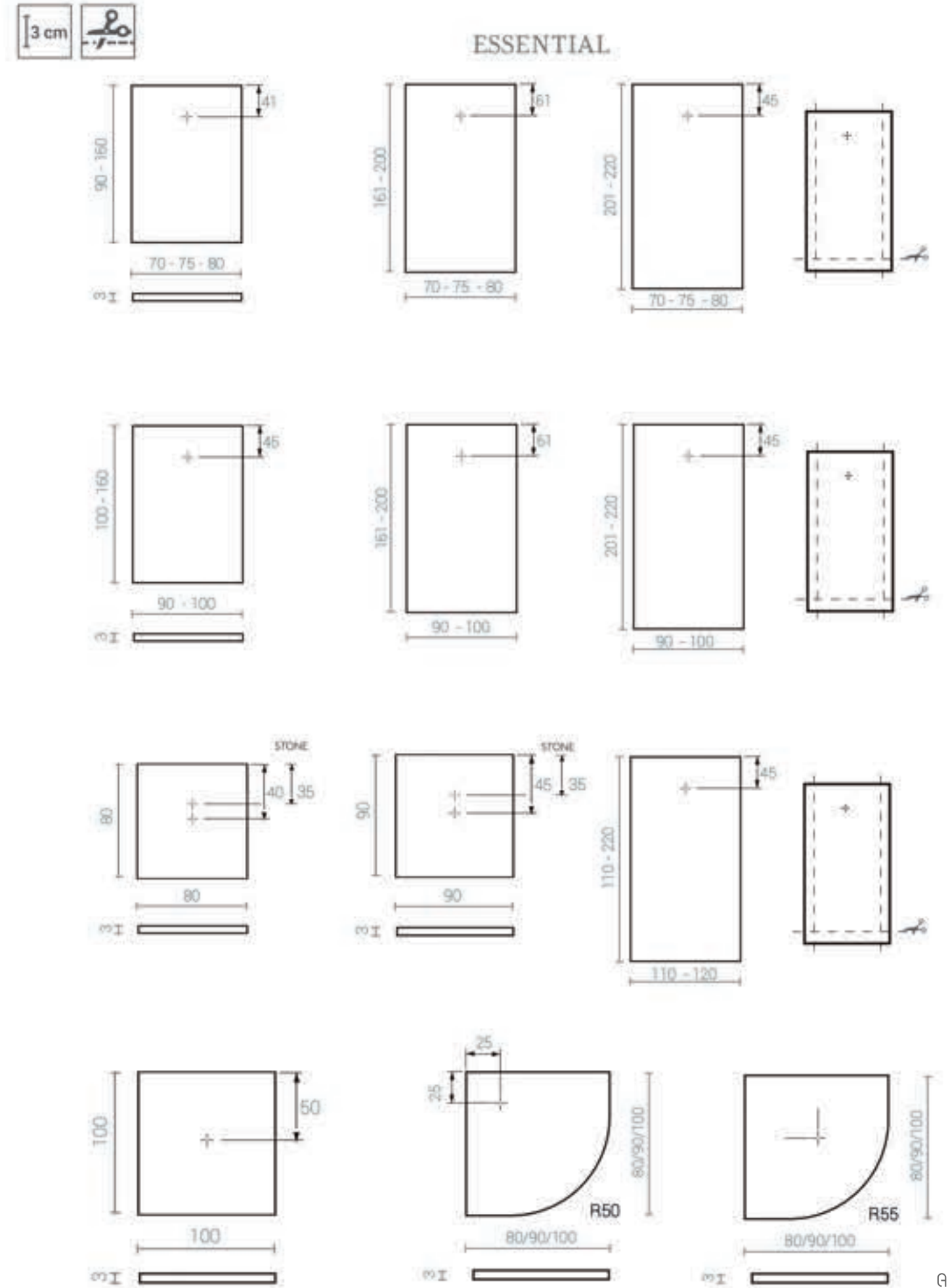



MATERIA

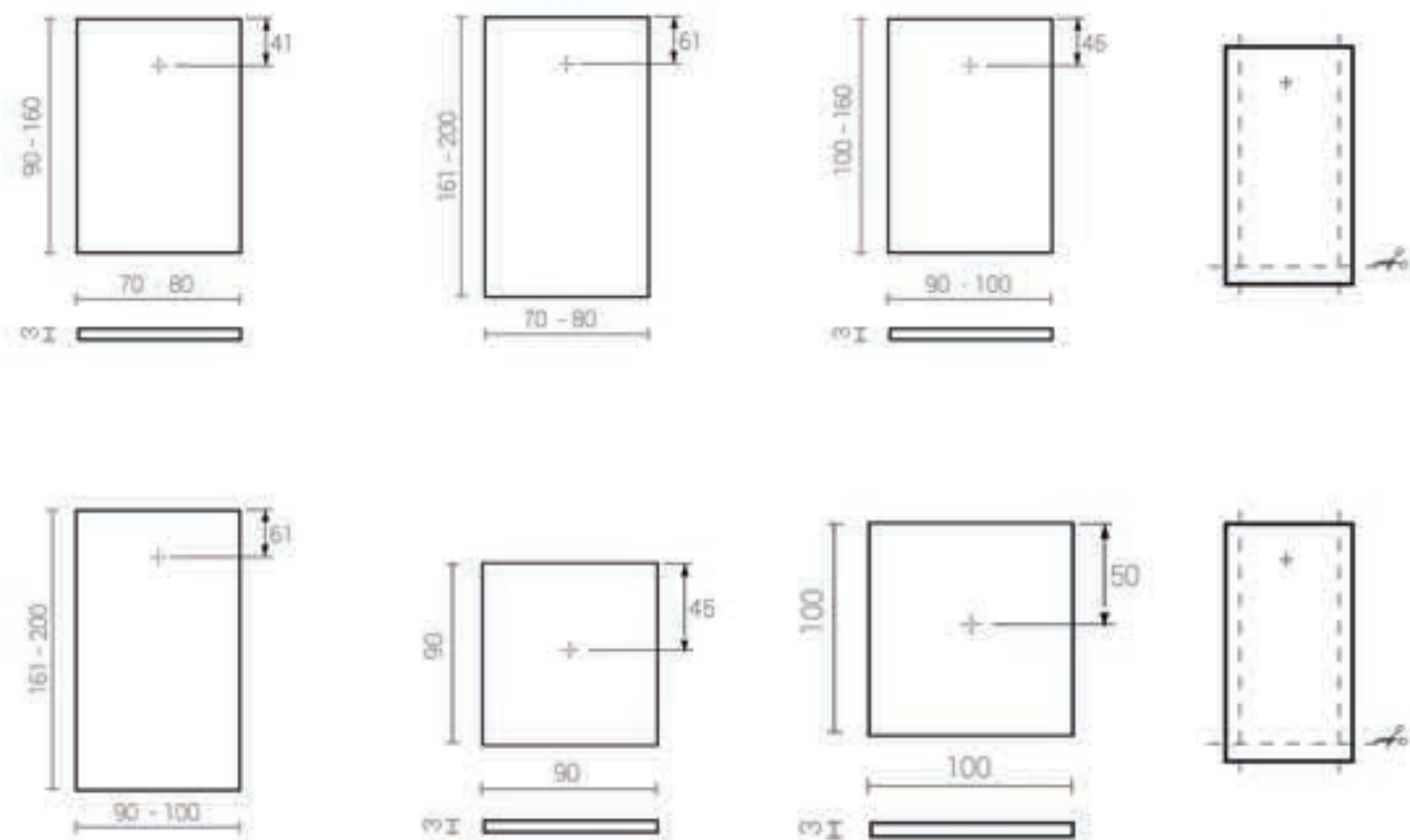

NEVO

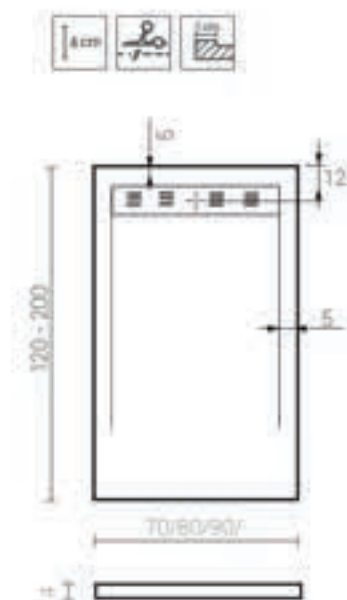

COVER

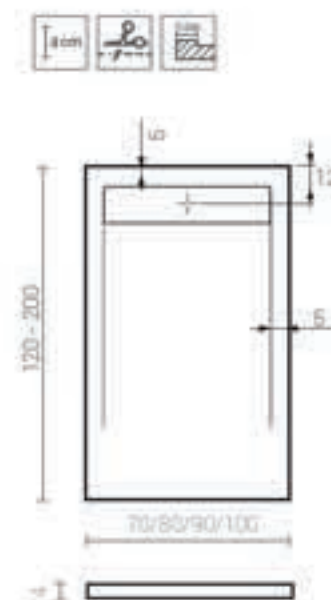

URBAN

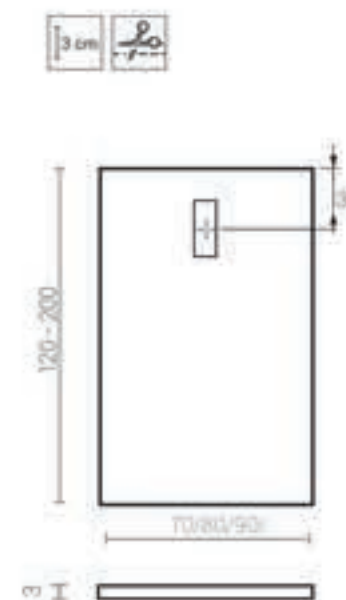

STUCCO

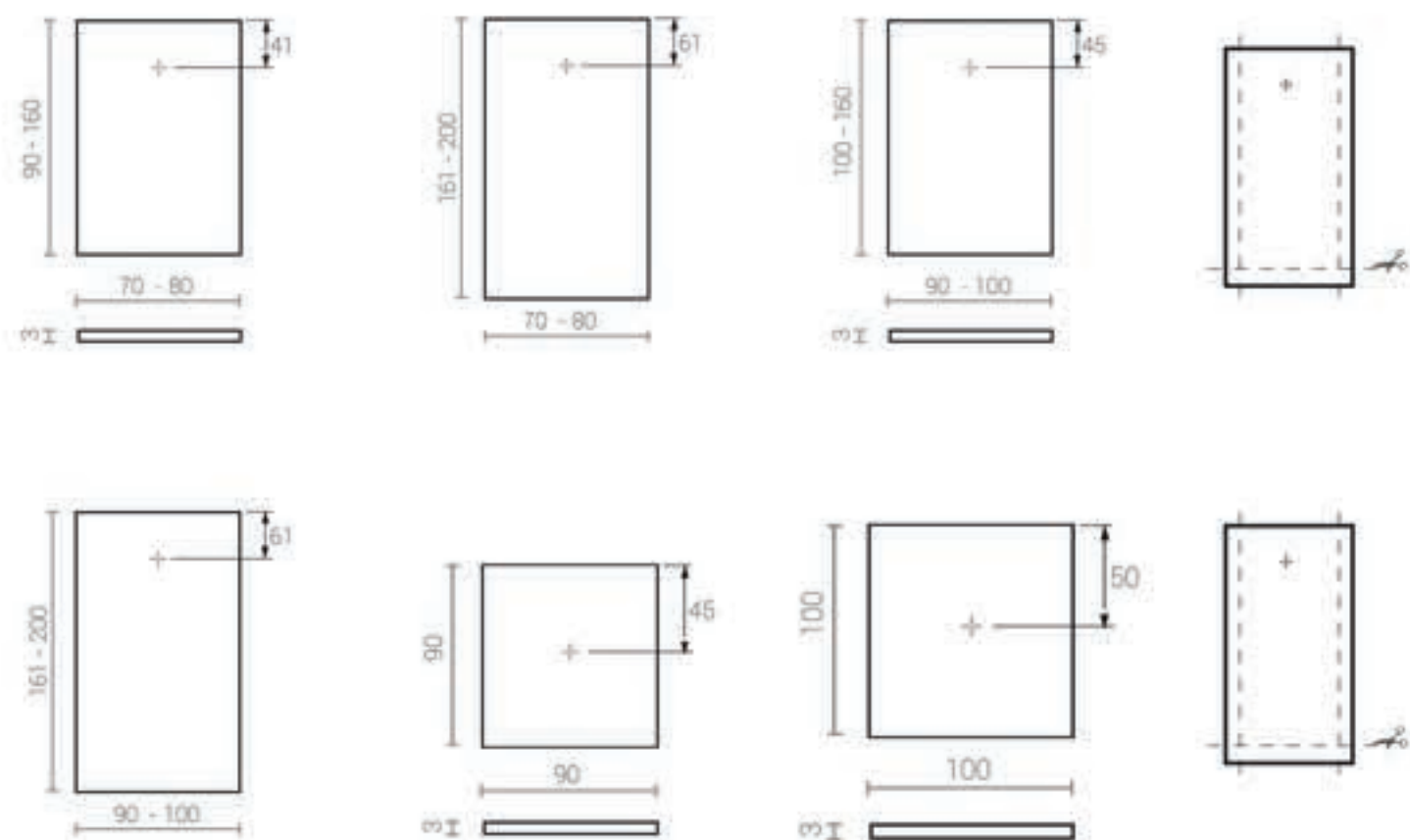

LOOK

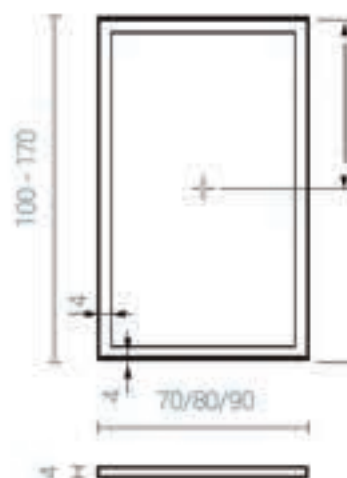
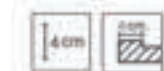

STUCCO PROJECT



CALATRAVA

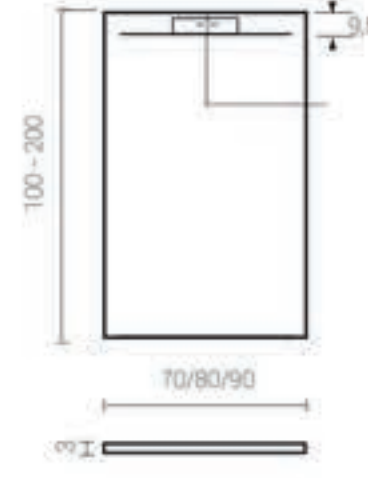
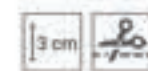

Antideslizamiento
Antiscivolo
Antidérapant
Antislip



Facilidad de corte
Facilità di taglio
Facile à découper
Easy to cut



Durabilidad
Durata
Durabilità
Durability



Resistente a la hidrólisis
Resistente all'idrolisi
Résistante à l'hydrolyse
Hydrolysis Resistant



Antibacteriano
Antibatterico
Antibactérien
Antibacterial



NCS disponibles
NCS disponibili
NCS disponibles
NCS available



Dupont Corian® es un material de superficie sólida, no poroso y de masa homogénea, compuesto por 1/3 de resina acrílica (conocida como polimetacrilato de metilo o PMMA) y 2/3 de minerales naturales. La carga principal es el trihidruro de aluminio (ATH), un derivado de la bauxita utilizado en la producción de aluminio. De color blanco opaco, la estructura del material es homogénea en todo su espesor, y las superficies son renovables en el sentido de que pueden repararse con un limpiador abrasivo o simplemente con scotch-brite. Dupont Corian® es un material higiénico y no poroso que impide la proliferación de bacterias o moho y, gracias a la presencia de trihidrato de aluminio en su composición, frena la propagación del fuego.

Dupont Corian® materiale solid Surface, non poroso e con massa omogenea, è costituito da 1/3 da resina acrilica (conosciuta come polimetilmetacrilato o PMMA) e 2/3 da minerali naturali. La carica principale è composta da triidrato di alluminio (ATH) un derivato della bauxite, utilizzato nella produzione di alluminio. Di Colore bianco opaco, la struttura del materiale è omogenea in tutto il suo spessore, e le superfici sono rinnovabili, nel senso che possono essere riprestinate con un detergente abrasivo o semplicemente con scotch-brite. Danni causati per uso improprio, possono essere riparati in situ, senza la necessità di sostituire il prodotto. Dupont Corian® un materiale igienico, già che è un materiale non poroso, e impedisce lo sviluppo di batteri o muffe, e grazie alla presenza nella sua composizione di triidrato di alluminio rallenta la propagazione del fuoco.

Dupont Corian® est un matériau de surface solide, non poreux, à la masse homogène, composé d'1/3 de résine acrylique (appelée polyméthacrylate de méthyle ou PMMA) et de 2/3 de minéraux naturels. La principale charge est le trihydrure d'aluminium (ATH), un dérivé de la bauxite utilisé dans la production d'aluminium. De couleur blanche opaque, la structure du matériau est homogène dans toute son épaisseur, et les surfaces sont renouvelables dans le sens où elles peuvent être réparées avec un nettoyeur abrasif ou simplement du scotch-brite. Dupont Corian® est un matériau hygiénique et non poreux qui empêche le développement de bactéries ou de moisissures et, grâce à la présence de trihydrate d'aluminium dans sa composition, ralentit la propagation du feu.

Dupont Corian® is a solid surface, non-porous material with a homogeneous mass, consisting of 1/3 acrylic resin (known as polymethyl methacrylate or PMMA) and 2/3 natural minerals. The main filler is aluminium trihydride (ATH), a bauxite derivative used in the production of aluminium. Opaque white in colour, the structure of the material is homogeneous throughout its thickness, and the surfaces are renewable in the sense that they can be repaired with an abrasive cleaner or simply scotch-brite.

Dupont Corian® is a hygienic, non-porous material that prevents the growth of bacteria or mould and, thanks to the presence of aluminium trihydrate in its composition, slows the spread of fire.

BAÑERA / VASCA / BAIGNOIRE / BATHTUB

		NAXOS	SIROS	CHIOS	ITACA	SYMI
ENSAJO / PROVA / ESSAI / TEST						
Aspecto y aptitud para la limpieza (valoración) Aspetto e pulizia (valutazione) Aspect et facilité de nettoyage (évaluation) Appearance and cleanability (assessment)	UNE-EN 14516+A1	✓	✓	✓	✓	✓
Estabilidad del fondo (valoración) Stabilità del fondo (valutazione) Stabilité du fond (évaluation) Stability of the fund (valuation)	UNE-EN 14516+A1	✓	✓	✓	✓	✓
Evacuación del agua (valoración) Evacuazione dell'acqua (valutazione) Évacuation de l'eau (évaluation) Water evacuation (assessment)	UNE-EN 14516+A1	✓	✓	✓	✓	✓
Resistencia a productos químicos y tintes (valoración) Resistenza agli agenti chimici e coloranti (valutazione) Résistance aux produits chimiques et aux colorants (évaluation) Resistance to chemicals and dyes (assessment)	UNE-EN 14516+A1	✓	✓	✓	✓	✓
Resistencia a los cambios de temperatura (valoración) Resistenza alle variazioni di temperatura (valutazione) Résistance aux variations de température (évaluation) Resistance to temperature changes (valuation)	UNE-EN 14516+A1	✓	✓	✓	✓	✓
Resistencia al calor seco a 180°C Aspecto (clasificación) Resistenza al calore secco a 180°C Aspetto (valutazione) Résistance à la chaleur sèche à 180°C Aspect (notation) Resistance to dry heat at 180°C Appearance (rating)	UNE-EN 14688 A 5.4	✓	✓	✓	✓	✓
Resistencia al calor seco a 180°C Defectos (clasificación) Resistenza al calore secco a 180°C Difetti (valutazione) Résistance à la chaleur sèche à 180°C Défauts (notation) Resistance to dry heat at 180°C Defects (rating)	UNE-EN 14688 A 5.4	✓	✓	✓	✓	✓
Protección contra el desbordamiento Protezione contro il traboccamento Protection contre le débordement Overflow protection	EN 14688 - A 5.9	0,25 / (0,01)	0,25 / (0,01)	0,25 / (0,01)	0,25 / (0,01)	0,25 / (0,01)

