

cool cement  
oversize  
grey soul  
technika  
terraforte  
bryce  
be\_marble  
astra  
olimpya  
athena  
north wind  
nautika

**TUSCANIA**  
gres porcellanato

signs of style





# signs of style

cool cement 2

oversize 16

grey soul 32

technika 42

terraforte 52

bryce 60

be\_marble 68

astra 76

olimpya 80

athena 84

north wind 94

nautika 102







## cool cement

Atmosfere e colori metropolitani per uno spazio ceramico attuale, espressione di una nuova forza decorativa dinamica al passo coi tempi. Superfici leggermente graffiate ci riportano ai materiali autentici delle attuali architetture con l'aggiunta di un ricordo romantico di chiara valenza storica: una forma esagonale.

Metropolitan atmospheres and colors, for a contemporary tiled space, reveal a new and dynamic, up to date decoration. Slightly scratched surfaces lead us to the real materials of the contemporary architecture with a proper romantic past. The hexagon.





cool cement



sand 75x75 cm R . 30"x30" R - 30,4x61,0 cm R . 12"x24" R  
mosaico mud 36 tessere 30x30 cm . 12"x12"





coal 61,0x61,0 cm R . 24"x24" R - ash 30,4x61,0 cm R . 12"x24" R  
mosaico ash 36 tessere 30x30 cm . 12"x12"



cool cement



# cool cement

Impasto Colorato  
Colored Body  
Masse Colorée  
Durchgefärbt



30,8x61,5 cm  
12"x24"

esagona  
30x34,5 cm  
12"x13"

**R** Rettificato - Rectified

**N** Naturale - Natural

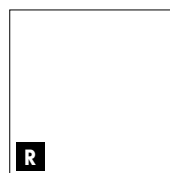

75x75 cm R . 30"x30" R

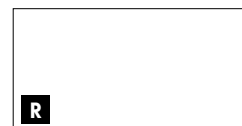

61,5x121 cm R . 24"x48" R

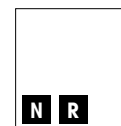

61,5x61,5 cm N . 24"x24" N  
61,0x61,0 cm R . 24"x24" R

## ash



75x75 cm 30"x30" **R**

61,5x61,5 cm 24"x24" **N**

61,0x61,0 cm 24"x24" **R**

61,5x121 cm 24"x48" **R**

30,8x61,5 cm 12"x24" **N**

30,4x61,0 cm 12"x24" **R**

## sand



75x75 cm 30"x30" **R**

61,5x61,5 cm 24"x24" **N**

61,0x61,0 cm 24"x24" **R**

61,5x121 cm 24"x48" **R**

30,8x61,5 cm 12"x24" **N**

30,4x61,0 cm 12"x24" **R**

## coal



75x75 cm 30"x30" **R**

61,5x61,5 cm 24"x24" **N**

61,0x61,0 cm 24"x24" **R**

61,5x121 cm 24"x48" **R**

30,8x61,5 cm 12"x24" **N**

30,4x61,0 cm 12"x24" **R**

## mud



75x75 cm 30"x30" **R**

61,5x61,5 cm 24"x24" **N**

61,0x61,0 cm 24"x24" **R**

61,5x121 cm 24"x48" **R**

30,8x61,5 cm 12"x24" **N**

30,4x61,0 cm 12"x24" **R**



30,8x61,5 cm N . 12"x24" N  
30,4x61,0 cm R . 12"x24" R



30x34,5 cm . 12"x13<sup>7/8</sup>"

esagona ash



30x34,5 cm 12"x13<sup>7/8</sup>"

esagona sand



30x34,5 cm 12"x13<sup>7/8</sup>"

esagona coal

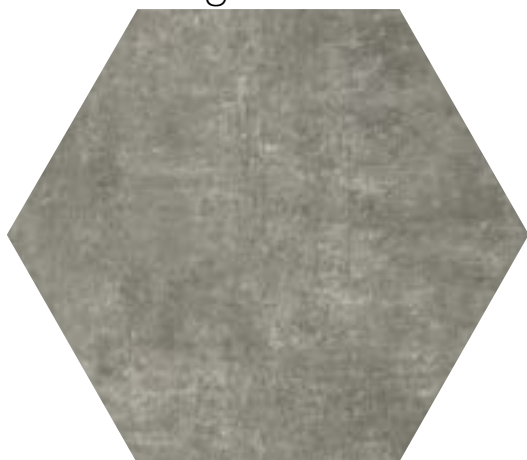

30x34,5 cm 12"x13<sup>7/8</sup>"

esagona mud



30x34,5 cm 12"x13<sup>7/8</sup>"

**V2**

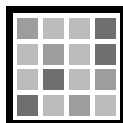

**MODERATE**

- La diversità di grafica e la naturale stonizzazione delle piastrelle costituiscono la caratteristica propria di questa serie. Si consiglia di miscelare le varie scatole durante la posa e di scegliere le piastrelle da diversi colli per evitare il ripetersi della stessa grafica accostata.
- The different graphics and the natural shading of each tile are intentional characteristics of this range. When laying tiles, we recommend mixing the various boxes and choosing tiles from different boxes, in order to avoid placing tiles with identical graphics adjacent to each other.
- La diversité graphique et la variété de tonalités naturelle des carreaux caractérisent cette série. Il est recommandé de mélanger les carreaux de différentes boîtes au cours de la pose et de les choisir dans différents colis pour éviter que les mêmes dessins ne se trouvent côte à côte.
- Die unterschiedlichen Maserungen und der natürlichen Farbspiel sind gewollten Eigenschaften dieser Serie. Bei der Verlegung es wird empfohlen Fliesen aus verschiedenen Kartons zu mischen.



# cool cement

sviluppo grafico . design development

ash

75x75 cm R . 30"x30" R

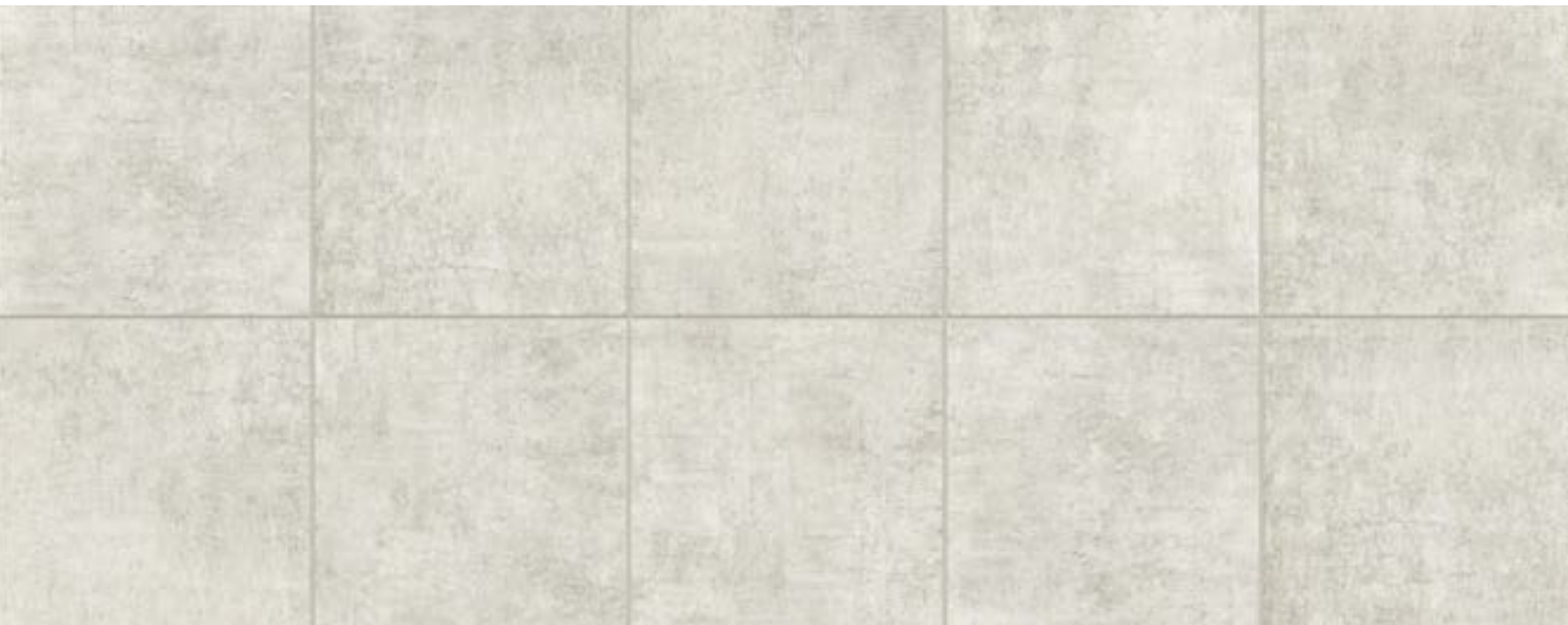

coal

61,5x121 cm R . 24"x48" R



cool cement

61,0x61,0 cm R . 24"x24" R

sand



30,8x61,5 cm N . 12"x24" N

mud



# cool cement

sviluppo grafico . design development

esagona ash

30x34,5 cm . 12"x13<sup>7/8</sup>"



esagona coal

30x34,5 cm . 12"x13<sup>7/8</sup>"





cool cement

30x34,5 cm . 12"x13<sup>7</sup>/<sub>8</sub>"

esagona sand



30x34,5 cm . 12"x13<sup>7</sup>/<sub>8</sub>"

esagona mud



# cool cement

decori - decors - décors - dekors

stripe 24 tessere 

ash

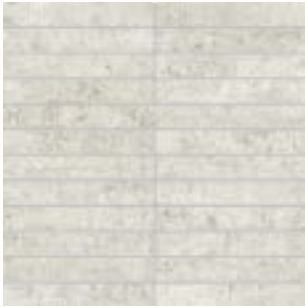

30x30 cm 12"x12"

coal



30x30 cm 12"x12"

sand

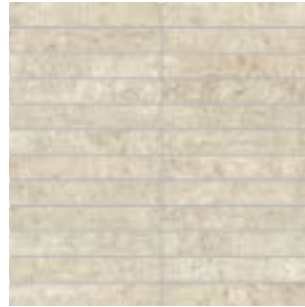

30x30 cm 12"x12"

mud



30x30 cm 12"x12"

mosaico 36 tessere 

ash



30x30 cm 12"x12"

coal

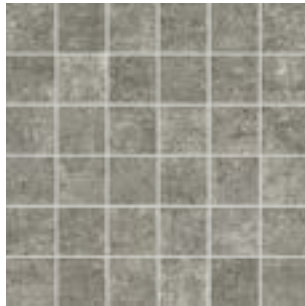

30x30 cm 12"x12"

sand



30x30 cm 12"x12"

mud

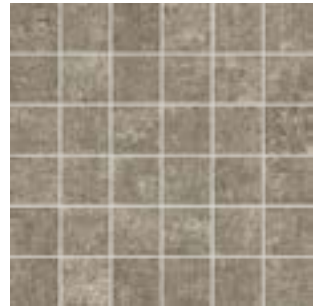

30x30 cm 12"x12"

decoro mix



61,0x61,0 cm 24"x24"

R

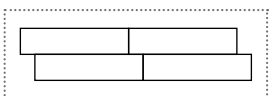

- Onde evitare problemi di planarità, per tutti i formati rettangolari si consiglia la posa sfalsata irregolare del prodotto come da schema.
- Irregular offset installation is advisable in the case of rectangular shaped products, to avoid problems associated with planarity. (See drawing).
- Pour tous les formats rectangulaires on conseille une pose décalée irrégulière afin d'éviter problèmes de planéité. (Observer le dessin).
- Um Planaritätsprobleme zu vermeiden, wird für die Rechteckischen Formate eine Eindrittelverlegung empfohlen, laut Skizze.

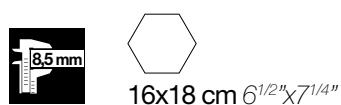

forme esacolor 

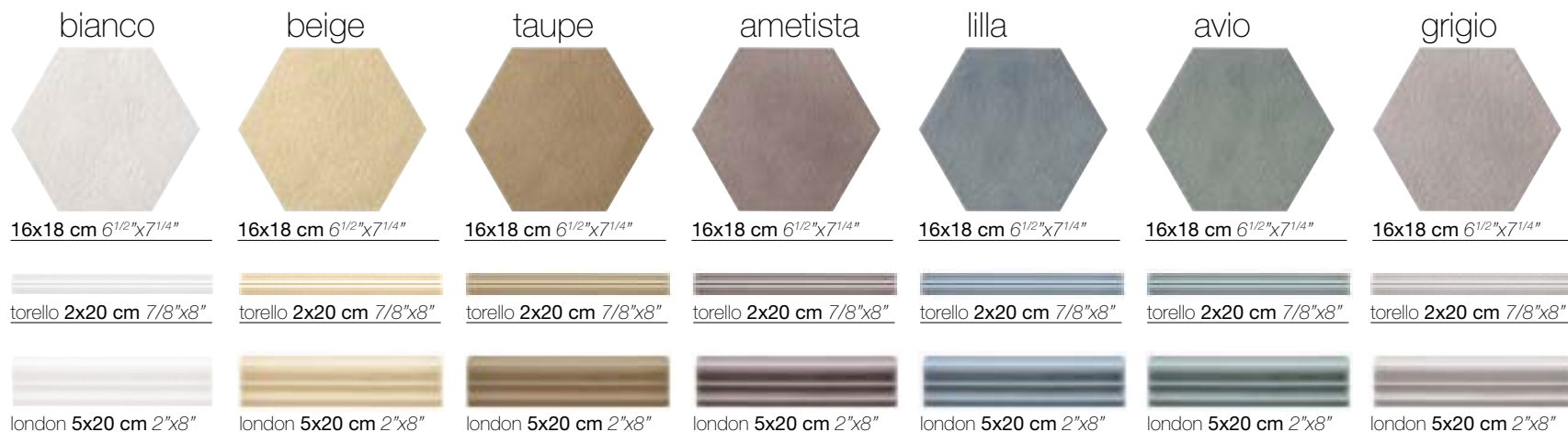

pezzi speciali - special pieces - pièces spéciales - formteile

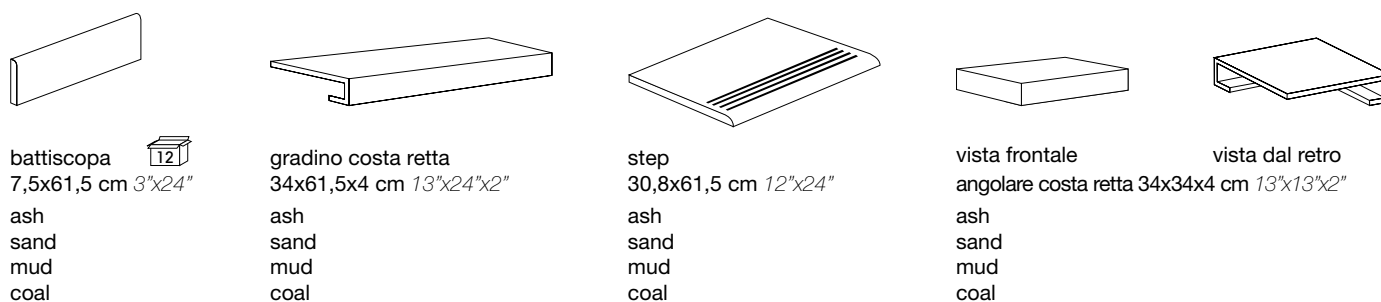

Note - Notes - Notes - Anmerkungen

I battiscopa vengono venduti a ml e a scatola completa. I gradini e gli angolari vengono venduti a pz e solo su ordinazione (tempo minimo di consegna 20 gg lavorativi dall'ordine).  
The skirting tiles are sold by linear meter and in complete boxes. The steps and corner pieces are sold by the part and only on request (minimum delivery time 20 working days from date of order).  
Les plinthes sont vendues au mètre linéaire et par boîte complète. Les marches et les angles sont vendus à la pièce et uniquement sur commande (délai minimum de livraison 20 jours ouvrés à partir de la commande).  
Preis der Sockelleisten ist pro lfm zu verstehen. Wird nur auf vollen Kartons verkauft. Stufen und Stufenecken werden nur auf Bestellung produziert (Lieferzeit mindestens 20 Arbeitstagen ab Auftragserteilung).  
Preis ist pro Stück zu verstehen. Bestellungen auch Stückweise möglich.

tabella pesi ed imballi - sizes weight and packaging - mesures poids et emballages - tabelle der gewichte und verpackungen

formati / sizes / tailles / formate	pz. x box	mq. x box	kg. x box	box x pal.	mq. x pal.	kg. x pal.
75x75 cm 30"x30" (rettificato)	2	1,13	26,00	45	52,85	1170
61,5x61,5 cm 24"x24" (naturale)	4	1,51	34,00	30	45,30	1020
61,0x61,0 cm 24"x24" (rettificato)	4	1,49	33,60	30	44,70	1000
61,5x121 cm 24"x48" (rettificato)	2	1,49	33,80	21	31,29	750
30,8x61,5 cm 12"x24" (naturale)	7	1,32	26,80	40	52,80	1100
30,4x61,0 cm 12"x24" (rettificato)	7	1,30	26,50	40	52,00	1060
30x34,5 cm 12"x13 7/8" esagona	16	1,28	22,00	34	43,52	750
61,0x61,0 cm 24"x24" decoro mix (rettificato)	4	1,49	33,60	30	44,70	1000
16x18 cm 6 1/2"x7 1/4" forme esacolor	46	1,00	15,80	64	64,00	1011
7,5x61,5 cm 3"x24" battiscopa	12	7,38/ml	14,50	80	590,40/ml	1180





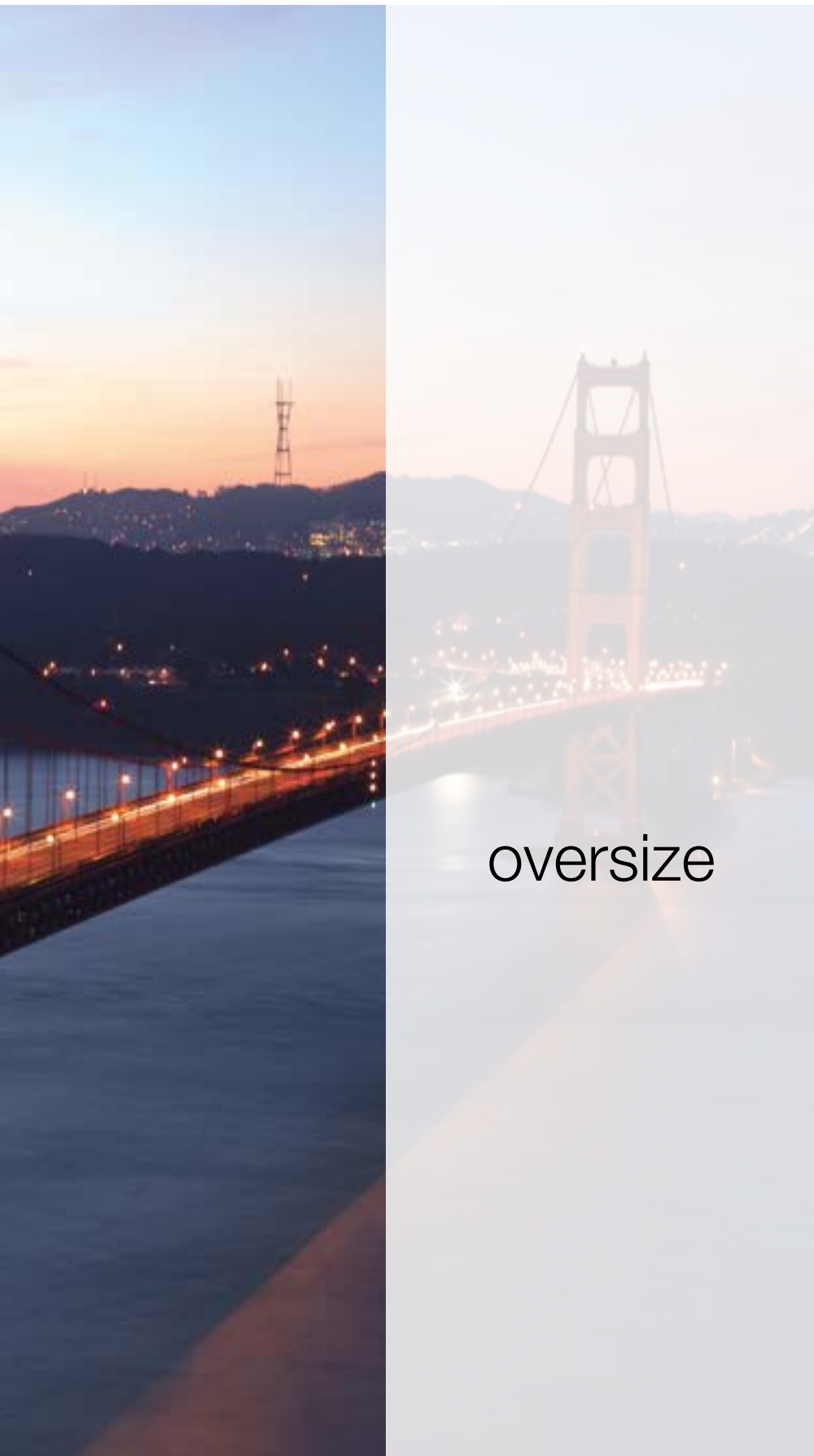

## oversize

Definizione, impatto grafico ed estetico delle superfici illimitato, frutto di una evoluzione tecnologica superiore ed esclusiva. Una nuova forza decorativa di gusto moderno consente di ottenere un numero illimitato di soluzioni decorative.

Composition, with a never ending graphic and aesthetic touch on the surfaces, as a result of a superior and exclusive technology. A new and modern decorative idea with endless possibilities.









oversize

tortora 61,0x61,0 cm R . 24"x24" R - decoro mix 61,0x61,0 cm R . 24"x24" R



grigio 61,0x61,0 cm R . 24"x24" R - 30,4x61,0 cm R . 12"x24" R - bianco 61,0x61,0 cm R . 24"x24" R - 30,4x61,0 cm R . 12"x24" R  
decoro code grigio 61,0x61,0 cm R . 24"x24" R - 30,4x61,0 cm R . 12"x24" R - decoro code bianco 61,0x61,0 cm R . 24"x24" R - 30,4x61,0 cm R . 12"x24" R



oversize





# oversize

Impasto Colorato  
Colored Body  
Masse Colorée  
Durchgefärbt



30,8x61,5 cm  
12"x24"

esagona  
30x34,5 cm  
12"x13"

**R** Rettificato - Rectified

**N** Naturale - Natural



75x75 cm R . 30"x30" R

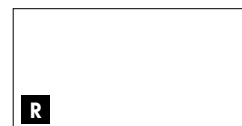

61,5x121 cm R . 24"x48" R

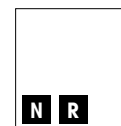

61,5x61,5 cm N . 24"x24" N  
61,0x61,0 cm R . 24"x24" R

## bianco



75x75 cm 30"x30"	<b>R</b>
61,5x61,5 cm 24"x24"	<b>N</b>
61,0x61,0 cm 24"x24"	<b>R</b>
61,5x121 cm 24"x48"	<b>R</b>
30,8x61,5 cm 12"x24"	<b>N</b>
30,4x61,0 cm 12"x24"	<b>R</b>

## taupe



75x75 cm 30"x30"	<b>R</b>
61,5x61,5 cm 24"x24"	<b>N</b>
61,0x61,0 cm 24"x24"	<b>R</b>
61,5x121 cm 24"x48"	<b>R</b>
30,8x61,5 cm 12"x24"	<b>N</b>
30,4x61,0 cm 12"x24"	<b>R</b>

## grigio

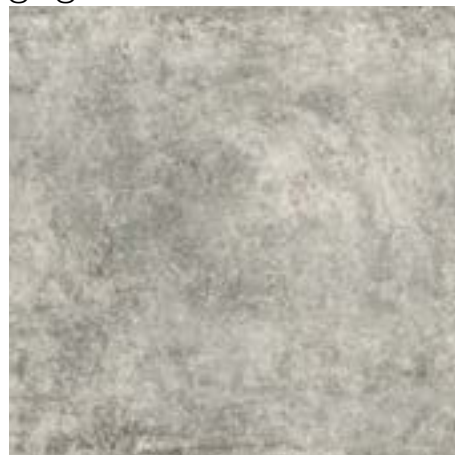

75x75 cm 30"x30"	<b>R</b>
61,5x61,5 cm 24"x24"	<b>N</b>
61,0x61,0 cm 24"x24"	<b>R</b>
61,5x121 cm 24"x48"	<b>R</b>
30,8x61,5 cm 12"x24"	<b>N</b>
30,4x61,0 cm 12"x24"	<b>R</b>

## tortora



75x75 cm 30"x30"	<b>R</b>
61,5x61,5 cm 24"x24"	<b>N</b>
61,0x61,0 cm 24"x24"	<b>R</b>
61,5x121 cm 24"x48"	<b>R</b>
30,8x61,5 cm 12"x24"	<b>N</b>
30,4x61,0 cm 12"x24"	<b>R</b>



30,8x61,5 cm N . 12"x24" N  
30,4x61,0 cm R . 12"x24" R



30x34,5 cm . 12"x13<sup>7/8</sup>"

esagona bianco



30x34,5 cm 12"x13<sup>7/8</sup>"

esagona taupe



30x34,5 cm 12"x13<sup>7/8</sup>"

esagona grigio



30x34,5 cm 12"x13<sup>7/8</sup>"

esagona tortora



30x34,5 cm 12"x13<sup>7/8</sup>"

**V2**

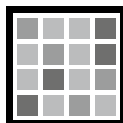

**MODERATE**

- La diversità di grafica e la naturale stonizzazione delle piastrelle costituiscono la caratteristica propria di questa serie. Si consiglia di miscelare le varie scatole durante la posa e di scegliere le piastrelle da diversi colli per evitare il ripetersi della stessa grafica accostata.
- The different graphics and the natural shading of each tile are intentional characteristics of this range. When laying tiles, we recommend mixing the various boxes and choosing tiles from different boxes, in order to avoid placing tiles with identical graphics adjacent to each other.
- La diversité graphique et la variété de tonalités naturelle des carreaux caractérisent cette série. Il est recommandé de mélanger les carreaux de différentes boîtes au cours de la pose et de les choisir dans différents colis pour éviter que les mêmes dessins ne se trouvent côte à côte.
- Die unterschiedlichen Maserungen und der natürlichen Farbspiel sind gewollten Eigenschaften dieser Serie. Bei der Verlegung es wird empfohlen Fliesen aus verschiedenen Kartons zu mischen.

# oversize

sviluppo grafico . design development

bianco

30,8x61,5 cm N . 12"x24" N



grigio

75x75 cm R . 30"x30" R





oversize

61,0x61,0 cm R . 24"x24" R

taupe



61,5x121 cm R . 24"x48" R

tortora



# oversize

sviluppo grafico . design development

esagona bianco

30x34,5 cm . 12"x13<sup>7/8</sup>"



esagona grigio

30x34,5 cm . 12"x13<sup>7/8</sup>"





oversize

30x34,5 cm . 12"x13<sup>7</sup>/<sub>8</sub>"

esagona taupe



30x34,5 cm . 12"x13<sup>7</sup>/<sub>8</sub>"

esagona tortora





# oversize

decori - decors - décors - dekors

## decoro code



\* Decoro 61,0x61,0 cm 24"x24"

**R**

bianco  
grigio  
taupe  
tortora

\* Disponibile in tutti i colori.  
Available in all colours.  
Disponibile dans toutes les gammes de couleur.  
In allen Farben verfügbar.

## decoro code



\* Decoro 30,4x61,0 cm 12"x24"

**R**

bianco  
grigio  
taupe  
tortora

\* Disponibile in tutti i colori.  
Available in all colours.  
Disponible dans toutes les gammes de couleur.  
In allen Farben verfügbar.

# oversize

decori - decors - décors - dekors

stripe 24 tessere 

bianco

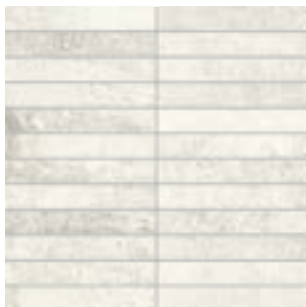

30x30 cm 12"x12"

grigio

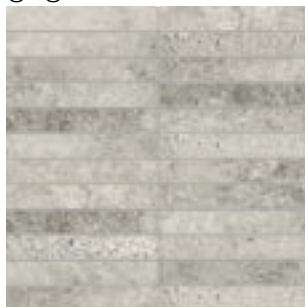

30x30 cm 12"x12"

taupe



30x30 cm 12"x12"

tortora

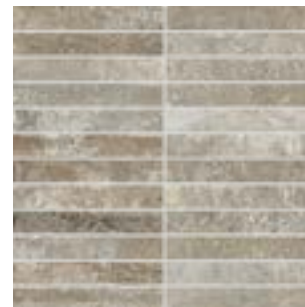

30x30 cm 12"x12"

mosaico 36 tessere 

bianco



30x30 cm 12"x12"

grigio



30x30 cm 12"x12"

taupe



30x30 cm 12"x12"

tortora

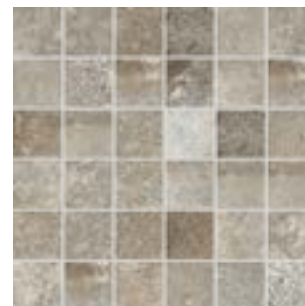

30x30 cm 12"x12"

decoro mix



61,0x61,0 cm 24"x24"

R

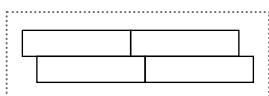

- Onde evitare problemi di planarità, per tutti i formati rettangolari si consiglia la posa sfalsata irregolare del prodotto come da schema.
- Irregular offset installation is advisable in the case of rectangular shaped products, to avoid problems associated with planarity. (See drawing).
- Pour tous les formats rectangulaires on conseille une pose décalée irrégulière afin d'éviter problèmes de planéité. (Observer le dessin).
- Um Planaritätsprobleme zu vermeiden, wird für die Rechteckischen Formate eine Eindrittelverlegung empfohlen, laut Skizze.



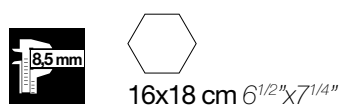

forme esacolor 

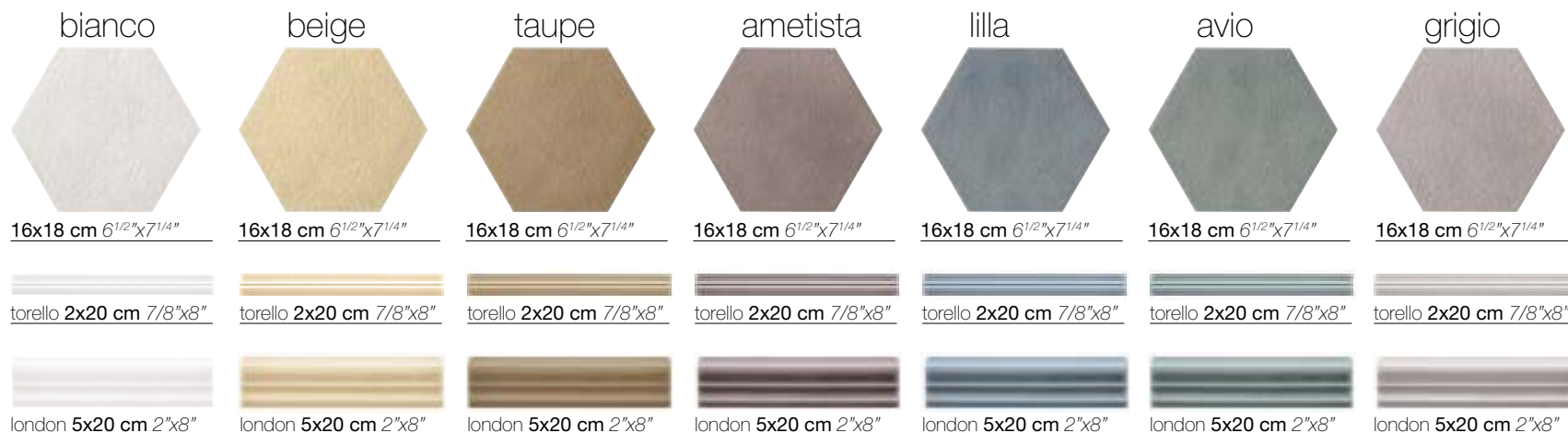

pezzi speciali - special pieces - pièces spéciales - formteile



**battiscopa**   
7,5x61,5 cm 3"x24"  
bianco  
grigio  
taupe  
tortora

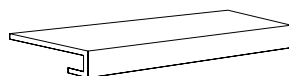

**gradino costa retta**  
34x61,5x4 cm 13"x24"x2"  
bianco  
grigio  
taupe  
tortora

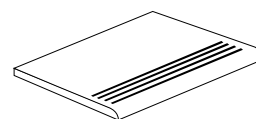

**step**  
30,8x61,5 cm 12"x24"  
bianco  
grigio  
taupe  
tortora



**vista frontale**  
angolare costa retta 34x34x4 cm 13"x13"x2"  
bianco  
grigio  
taupe  
tortora

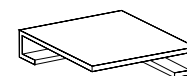

**vista dal retro**

Note - Notes - Notes - Anmerkungen

I battiscopa vengono venduti a ml e a scatola completa. I gradini e gli angolari vengono venduti a pz e solo su ordinazione (tempo minimo di consegna 20 gg lavorativi dall'ordine).  
The skirting tiles are sold by linear meter and in complete boxes. The steps and corner pieces are sold by the part and only on request (minimum delivery time 20 working days from date of order).  
Les plinthes sont vendues au mètre linéaire et par boîte complète. Les marches et les angles sont vendus à la pièce et uniquement sur commande (délai minimum de livraison 20 jours ouvrés à partir de la commande).  
Preis der Sockelleisten ist pro lfm zu verstehen. Wird nur auf vollen Kartons verkauft. Stufen und Stufenecken werden nur auf Bestellung produziert (Lieferzeit mindestens 20 Arbeitstagen ab Auftragserteilung).  
Preis ist pro Stück zu verstehen. Bestellungen auch Stückweise möglich.

tabella pesi ed imballi - sizes weight and packaging - mesures poids et emballages - tabelle der gewichte und verpackungen

formati / sizes / tailles / formate	pz. x box	mq. x box	kg. x box	box x pal.	mq. x pal.	kg. x pal.
75x75 cm 30"x30" (rettificato)	2	1,13	26,00	45	52,85	1170
61,5x61,5 cm 24"x24" (naturale)	4	1,51	34,00	30	45,30	1020
61,0x61,0 cm 24"x24" (rettificato)	4	1,49	33,60	30	44,70	1000
61,5x121 cm 24"x48" (rettificato)	2	1,49	33,80	21	31,29	750
30,8x61,5 cm 12"x24" (naturale)	7	1,32	26,80	40	52,80	1100
30,4x61,0 cm 12"x24" (rettificato)	7	1,30	26,50	40	52,00	1060
30x34,5 cm 12"x13 7/8" esagona	16	1,28	22,00	34	43,52	750
61,0x61,0 cm 24"x24" decoro mix (rettificato)	4	1,49	33,60	30	44,70	1000
61,0x61,0 cm 24"x24" decoro code (rettificato)	4	1,49	33,60	30	44,70	1000
30,4x61,0 cm 12"x24" decoro code (rettificato)	7	1,30	29,40	40	52,00	1180
16x18 cm 6 1/2"x7 1/4" forme esacolor	46	1,00	15,80	64	64,00	1011
7,5x61,5 cm 3"x24" battiscopa	12	7,38/ml	14,50	80	590,40/ml	1180





## grey soul

Una superficie mossa da un impercettibile bassorilievo trasmette dinamicità ad un prodotto ricco di formati e colori. Si tratta di una linea dall'impatto sorprendentemente hi-tech e contemporaneo, arricchita da una proposta spessorata utilizzabile sia per pavimenti interni ad alto carico che per pavimenti esterni posati su massetto oppure a secco, su ghiaia, terra e sabbia.

A light structured surface gives vitality to a full of colors and sizes collection. A high tech and up to date feeling, completed by high thickness proposals , suitable for indoor and outdoor heavy duty floors, with ordinary fixing methods or dry laying on gravel, sand, grass.







grey soul

white 75x75 cm R . 30"x30" R

# grey soul

Impasto Colorato  
Colored Body  
Masse Colorée  
Durchgefärbt



30,8x61,5 cm  
12"x24"

**R** Rettificato - Rectified

**N** Naturale - Natural

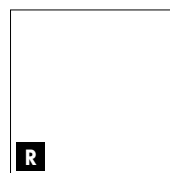

75x75 cm R . 30"x30" R

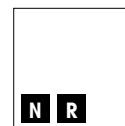

61,5x61,5 cm N . 24"x24" N  
61,0x61,0 cm R . 24"x24" R

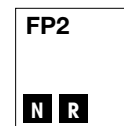

61,5x61,5 cm N . 24"x24" N  
61,0x61,0 cm R . 24"x24" R

## white



75x75 cm 30"x30"	<b>R</b>
61,5x61,5 cm 24"x24"	<b>N</b>
61,0x61,0 cm 24"x24"	<b>R</b>
44,4x89,4 cm 17 <sup>3/4</sup> "x35 <sup>7/8</sup> "	<b>R</b>
30,8x61,5 cm 12"x24"	<b>N</b>
30,4x61,0 cm 12"x24"	<b>R</b>
21,8x89,4 cm 8 <sup>7/8</sup> "x35 <sup>7/8</sup> "	<b>R</b>

## sand



75x75 cm 30"x30"	<b>R</b>
61,5x61,5 cm 24"x24"	<b>N</b>
61,5x61,5 cm 24"x24" <b>R11</b>	<b>N</b>
61,5x61,5 cm 24"x24" FP2	<b>N</b>
61,0x61,0 cm 24"x24"	<b>R</b>
61,0x61,0 cm 24"x24" FP2	<b>R</b>
44,4x89,4 cm 17 <sup>3/4</sup> "x35 <sup>7/8</sup> "	<b>R</b>
30,8x61,5 cm 12"x24"	<b>N</b>
30,8x61,5 cm 12"x24" <b>R11</b>	<b>N</b>
30,4x61,0 cm 12"x24"	<b>R</b>
21,8x89,4 cm 8 <sup>7/8</sup> "x35 <sup>7/8</sup> "	<b>R</b>

## V2

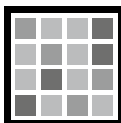

**MODERATE**

- La diversità di grafica e la naturale stonizzazione delle piastrelle costituiscono la caratteristica propria di questa serie. Si consiglia di miscelare le varie scatole durante la posa e di scegliere le piastrelle da diversi colli per evitare il ripetersi della stessa grafica accostata.
- The different graphics and the natural shading of each tile are intentional characteristics of this range. When laying tiles, we recommend mixing the various boxes and choosing tiles from different boxes, in order to avoid placing tiles with identical graphics adjacent to each other.
- La diversité graphique et la variété de tonalités naturelle des carreaux caractérisent cette série. Il est recommandé de mélanger les carreaux de différentes boîtes au cours de la pose et de les choisir dans différents colis pour éviter que les mêmes dessins ne se trouvent côte à côte.
- Die unterschiedlichen Maserungen und der natürlichen Farbspiel sind gewollten Eigenschaften dieser Serie. Bei der Verlegung es wird empfohlen Fliesen aus verschiedenen Kartons zu mischen.





45x90 cm R . 18"x36" N  
44,4x89 cm R . 17<sup>3/4</sup>"x35<sup>7/8</sup>" R



44,4x89,4 cm R . 17<sup>3/4</sup>"x35<sup>7/8</sup>" R



21,8x89,4 cm R . 8<sup>7/8</sup>"x35<sup>7/8</sup>" R



30,8x61,5 cm N . 12"x24" N  
30,4x61,0 cm R . 12"x24" R

light



75x75 cm 30"x30"	R
61,5x61,5 cm 24"x24"	N
61,5x61,5 cm 24"x24" FP2	N
61,0x61,0 cm 24"x24"	R
61,0x61,0 cm 24"x24" FP2	R
45x90 cm 18"x36" FP2	N
44,4x89 cm 17 <sup>3/4</sup> "x35 <sup>7/8</sup> " FP2	R
44,4x89,4 cm 17 <sup>3/4</sup> "x35 <sup>7/8</sup> "	R
30,8x61,5 cm 12"x24"	N
30,4x61,0 cm 12"x24"	R
21,8x89,4 cm 8 <sup>7/8</sup> "x35 <sup>7/8</sup> "	R

mid



75x75 cm 30"x30"	R
61,5x61,5 cm 24"x24"	N
61,5x61,5 cm 24"x24" R11	N
61,5x61,5 cm 24"x24" FP2	N
61,0x61,0 cm 24"x24"	R
61,0x61,0 cm 24"x24" FP2	R
45x90 cm 18"x36" FP2	N
44,4x89 cm 17 <sup>3/4</sup> "x35 <sup>7/8</sup> " FP2	R
44,4x89,4 cm 17 <sup>3/4</sup> "x35 <sup>7/8</sup> "	R
30,8x61,5 cm 12"x24"	N
30,8x61,5 cm 12"x24" R11	N
30,4x61,0 cm 12"x24"	R
21,8x89,4 cm 8 <sup>7/8</sup> "x35 <sup>7/8</sup> "	R

dark



75x75 cm 30"x30"	R
61,5x61,5 cm 24"x24"	N
61,5x61,5 cm 24"x24" R11	N
61,5x61,5 cm 24"x24" FP2	N
61,0x61,0 cm 24"x24"	R
61,0x61,0 cm 24"x24" FP2	R
45x90 cm 18"x36" FP2	N
44,4x89 cm 17 <sup>3/4</sup> "x35 <sup>7/8</sup> " FP2	R
44,4x89,4 cm 17 <sup>3/4</sup> "x35 <sup>7/8</sup> "	R
30,8x61,5 cm 12"x24"	N
30,8x61,5 cm 12"x24" R11	N
30,4x61,0 cm 12"x24"	R
21,8x89,4 cm 8 <sup>7/8</sup> "x35 <sup>7/8</sup> "	R

dark

61,5x61,5 cm N . 24"x24" N



decori - decors - décors - dekors

listello patchwork 

white



30,2x61,0 cm 12"x24"

sand



30,2x61,0 cm 12"x24"

light



30,2x61,0 cm 12"x24"

mid



30,2x61,0 cm 12"x24"

dark



30,2x61,0 cm 12"x24"

tris monocolori

white



44,4x89,4 cm 17<sup>3</sup>/<sub>4</sub>"x35<sup>7</sup>/<sub>8</sub>"



sand



44,4x89,4 cm 17<sup>3</sup>/<sub>4</sub>"x35<sup>7</sup>/<sub>8</sub>"



light



44,4x89,4 cm 17<sup>3</sup>/<sub>4</sub>"x35<sup>7</sup>/<sub>8</sub>"



mid



44,4x89,4 cm 17<sup>3</sup>/<sub>4</sub>"x35<sup>7</sup>/<sub>8</sub>"



dark



44,4x89,4 cm 17<sup>3</sup>/<sub>4</sub>"x35<sup>7</sup>/<sub>8</sub>"





# grey soul

mosaico monocolor 36 tessere 

white



30x30 cm 12"x12"

sand



30x30 cm 12"x12"

light

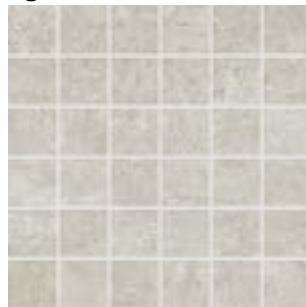

30x30 cm 12"x12"

mid



30x30 cm 12"x12"

dark



30x30 cm 12"x12"

decoro mix

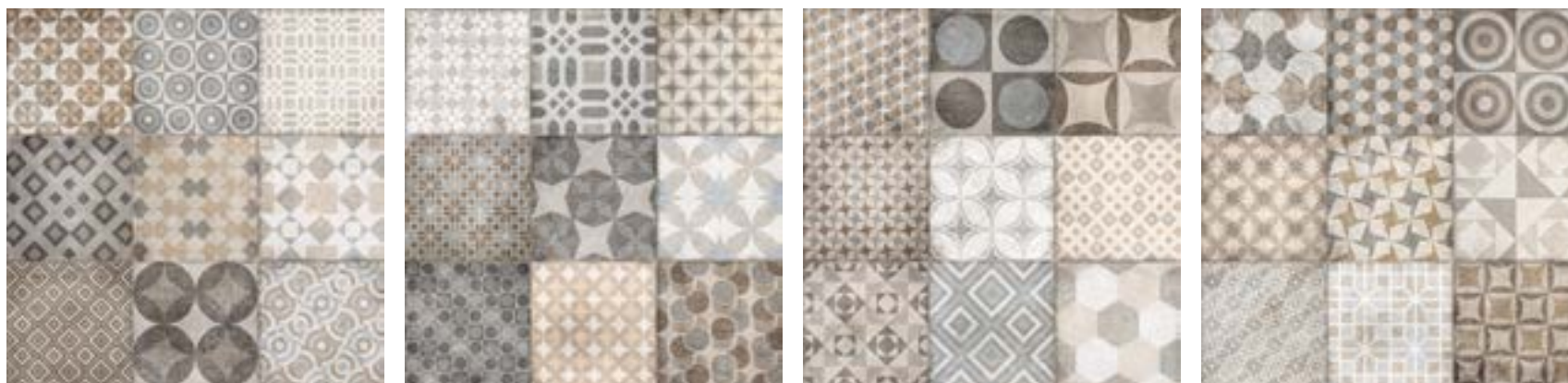

61,0x61,0 cm 24"x24"

R



16x18 cm 6 1/2"x7 1/4"

forme esacolor 

bianco



16x18 cm 6 1/2"x7 1/4"

beige



16x18 cm 6 1/2"x7 1/4"

taupe



16x18 cm 6 1/2"x7 1/4"

ametista



16x18 cm 6 1/2"x7 1/4"

lilla



16x18 cm 6 1/2"x7 1/4"

avio



16x18 cm 6 1/2"x7 1/4"

grigio



16x18 cm 6 1/2"x7 1/4"

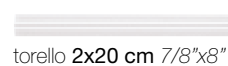

torello 2x20 cm 7/8"x8"

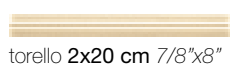

torello 2x20 cm 7/8"x8"

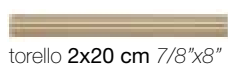

torello 2x20 cm 7/8"x8"

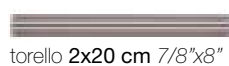

torello 2x20 cm 7/8"x8"

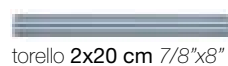

torello 2x20 cm 7/8"x8"

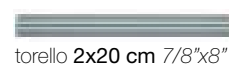

torello 2x20 cm 7/8"x8"

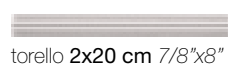

torello 2x20 cm 7/8"x8"

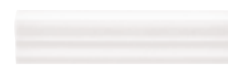

london 5x20 cm 2"x8"



london 5x20 cm 2"x8"



london 5x20 cm 2"x8"



london 5x20 cm 2"x8"



london 5x20 cm 2"x8"



london 5x20 cm 2"x8"



london 5x20 cm 2"x8"

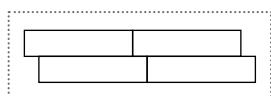

- Onde evitare problemi di planarità, per tutti i formati rettangolari si consiglia la posa sfalsata irregolare del prodotto come da schema.
- Irregular offset installation is advisable in the case of rectangular shaped products, to avoid problems associated with planarity. (See drawing).
- Pour tous les formats rectangulaires on conseille une pose décalée irrégulière afin d'éviter problèmes de planéité. (Observer le dessin).
- Um Planaritätsprobleme zu vermeiden, wird für die Rechteckischen Formate eine Eindrittelverlegung empfohlen, laut Skizze.

mosaico mix 81 tessere 



30x30 cm 12"x12"

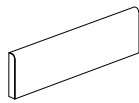

**battiscopa**   
7,5x61,5 cm 3"x24"  
white  
sand  
light  
mid  
dark

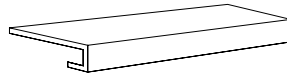

**gradino costa retta**  
34x61,5x4 cm 13"x24"x2"  
white  
sand  
light  
mid  
dark

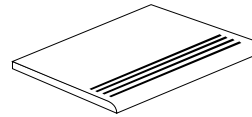

**step**  
30,8x61,5 cm 12"x24"  
white  
sand  
light  
mid  
dark

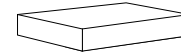

**vista frontale**  
angolare costa retta 34x34x4 cm 13"x13"x2"  
white  
sand  
light  
mid  
dark

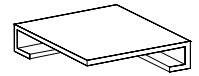

**vista dal retro**  
angolare costa retta 34x34x4 cm 13"x13"x2"  
white  
sand  
light  
mid  
dark

pezzi speciali - special pieces - pièces spéciales - formteile

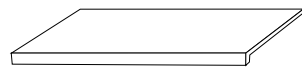



**elemento "L"**  
\*45x90x5 cm 18"x36"x2"  
30x61,5x5 cm 12"x24"x2"  
sand  
\*light  
\*mid  
\*dark



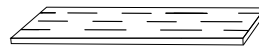

**angolare elemento "L"**  
\*45x45x5 cm 18"x18"x2"  
30x30x5 cm 12"x12"x2"  
sand  
\*light  
\*mid  
\*dark



**griglia**  
\*20x89 cm 8"x35<sup>7/8</sup>" R   
20x61,0 cm 8"x24" R   
sand  
\*light  
\*mid  
\*dark



**angolo SX**  
griglia angolo \*20x89 cm 8"x35<sup>7/8</sup>" R   
20x61,0 cm 8"x24" R   
sand  
\*light  
\*mid  
\*dark

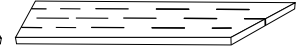

**angolo DX**  
sand  
\*light  
\*mid  
\*dark

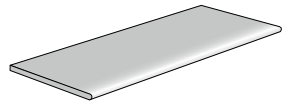

**round lineare**  
\*45x90 cm 18"x36"  
30x61,5 cm 12"x24"  
sand  
\*light  
\*mid  
\*dark

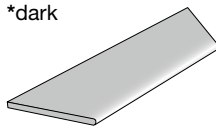

**angolo SX**  
round angolare \*45x90 cm 18"x36"  
30x61,5 cm 12"x24"  
sand  
\*light  
\*mid  
\*dark

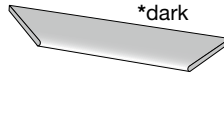

**angolo DX**  
sand  
\*light  
\*mid  
\*dark

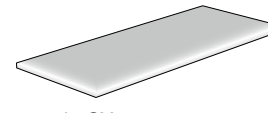

**angolo SX**  
angolo bordo toro \*45x90 cm 18"x36"  
30x61,5 cm 12"x24"  
sand  
\*light  
\*mid  
\*dark

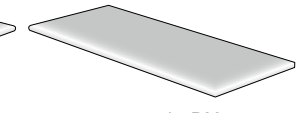

**angolo DX**  
sand  
\*light  
\*mid  
\*dark

Note - Notes - Notes - Anmerkungen

I battiscopa vengono venduti a ml e a scatola completa. I gradini e gli angolari vengono venduti a pz e solo su ordinazione (tempo minimo di consegna 20 gg lavorativi dall'ordine).  
The skirting tiles are sold by linear meter and in complete boxes. The steps and corner pieces are sold by the part and only on request (minimum delivery time 20 working days from date of order).  
Les plinthes sont vendues au mètre linéaire et par boîte complète. Les marches et les angles sont vendus à la pièce et uniquement sur commande (délai minimum de livraison 20 jours ouvrés à partir de la commande).  
Preis der Sockelleisten ist pro lfm zu verstehen. Wird nur auf vollen Kartons verkauft. Stufen und Stufenecken werden nur auf Bestellung produziert (Lieferzeit mindestens 20 Arbeitstagen ab Auftragserteilung).  
Preis ist pro Stück zu verstehen. Bestellungen auch Stückweise möglich.

tabella pesi ed imballi - sizes weight and packaging - mesures poids et emballages - tabelle der gewichte und verpackungen

formati / sizes / tailles / formate	pz. x box	mq. x box	kg. x box	box x pal.	mq. x pal.	kg. x pal.
75x75 cm 30"x30" (rettificato)	2	1,13	26,00	45	50,85	1170
61,5x61,5 cm 24"x24" (naturale)	4	1,51	34,00	30	45,30	1020
61,5x61,5 cm 24"x24" R11 (naturale)	4	1,51	34,00	30	45,30	1020
61,5x61,5 cm 24"x24" FP2 (naturale)	2	0,76	35,00	30	22,80	1050
61,0x61,0 cm 24"x24" (rettificato)	4	1,49	33,60	30	44,70	1000
61,0x61,0 cm 24"x24" FP2 (rettificato)	2	0,73	33,00	30	21,90	1000
45x90 cm 18"x36" FP2 (naturale)	2	0,81	36,50	27	21,87	1000
44,4x89 cm 17 <sup>3/4</sup> "x35 <sup>7/8</sup> " FP2 (rettificato)	2	0,79	35,50	27	21,33	970
44,4x89,4 cm 17 <sup>3/4</sup> "x35 <sup>7/8</sup> " (rettificato)	3	1,19	26,20	32	38,08	850
30,8x61,5 cm 12"x24" (naturale)	7	1,32	26,80	40	52,80	1100
30,8x61,5 cm 12"x24" R11 (naturale)	7	1,32	26,80	40	52,80	1160
30,4x61,0 cm 12"x24" (rettificato)	7	1,30	26,50	40	52,00	1060
21,8x89,4 cm 8 <sup>7/8</sup> "x35 <sup>7/8</sup> " (rettificato)	5	0,97	21,50	60	58,20	1300
61,0x61,0 cm 24"x24" decoro mix (rettificato)	4	1,49	33,60	30	44,70	1000
44,4x89,4 cm 17 <sup>3/4</sup> "x35 <sup>7/8</sup> " tris monocolor (rettificato)	3	1,19	26,20	32	38,08	850
16x18 cm 6 <sup>1/2</sup> "x7 <sup>1/4</sup> " forme esacolor	46	1,00	15,80	64	64,00	1011
7,5x61,5 cm 3"x24" battiscopa	12	7,38/ml	14,50	80	590,40/ml	1180





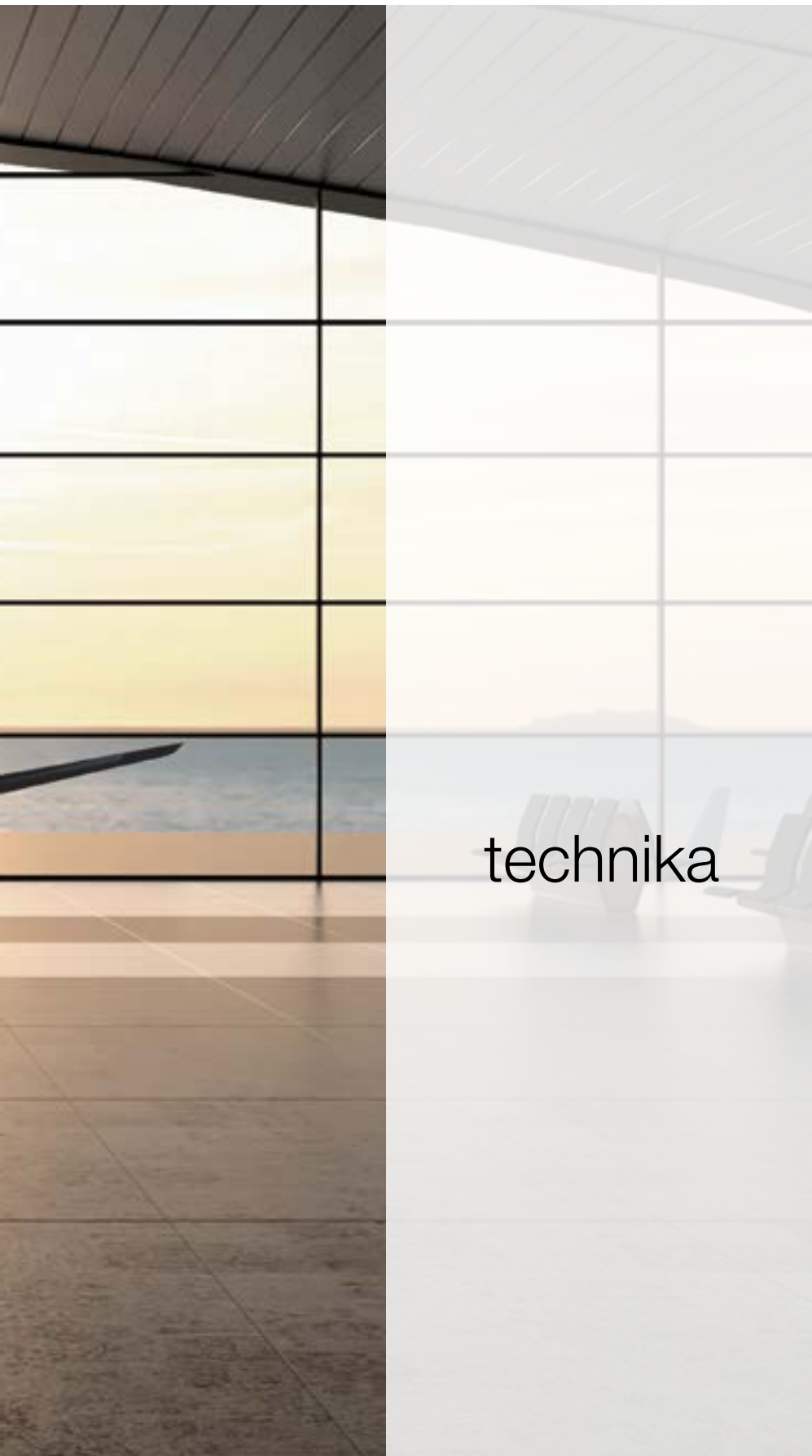

technika

La superficie ceramica vista come una esaltazione tecnica. Caratteristiche estetiche e di resistenza rilevanti per un materiale consigliato nell'impiego pubblico e nel commerciale. Uffici, negozi, aeroporti, supermercati, bar...qui "Technika" vince senza paragoni!

Ceramic tiled surfaces as the result of advanced technologies. Aesthetic and strength features for materials designed for commercial and public spaces. Shops, offices, airports, supermarkets. These are the proper places for Technika.



technika



bianco 61,0x61,0 cm R . 24"x24" R





# tecnica

Impasto Colorato  
Colored Body  
Masse Colorée  
Durchgefärbt



30,8x61,5 cm  
12"x24"  
45,5x45,5 cm  
18<sup>1/4</sup>"x18<sup>1/4</sup>"

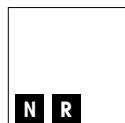

61,5x61,5 cm N . 24"x24" N  
61,0x61,0 cm R . 24"x24" R

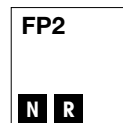

61,5x61,5 cm N . 24"x24" N  
61,0x61,0 cm R . 24"x24" R



45,5x45,5 cm N . 18<sup>1/4</sup>"x18<sup>1/4</sup>" N

**R** Rettificato - Rectified

**N** Naturale - Natural

**S** Strutturato - Textured

## beige



61,5x61,5 cm 24"x24"	<b>N</b>
61,0x61,0 cm 24"x24"	<b>R</b>
30,8x61,5 cm 12"x24"	<b>N</b>
45,5x45,5 cm 18 <sup>1/4</sup> "x18 <sup>1/4</sup> "	<b>N</b>
44,4x89,4 cm 17 <sup>3/4</sup> "x35 <sup>7/8</sup> "	<b>R</b>

## taupe



61,5x61,5 cm 24"x24"	<b>N</b>
61,0x61,0 cm 24"x24"	<b>R</b>
30,8x61,5 cm 12"x24"	<b>N</b>
45,5x45,5 cm 18 <sup>1/4</sup> "x18 <sup>1/4</sup> "	<b>N</b>
44,4x89,4 cm 17 <sup>3/4</sup> "x35 <sup>7/8</sup> "	<b>R</b>

## V2

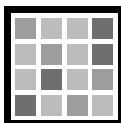

**MODERATE**

- La diversità di grafica e la naturale stonizzazione delle piastrelle costituiscono la caratteristica propria di questa serie. Si consiglia di miscelare le varie scatole durante la posa e di scegliere le piastrelle da diversi colli per evitare il ripetersi della stessa grafica accostata.
- The different graphics and the natural shading of each tile are intentional characteristics of this range. When laying tiles, we recommend mixing the various boxes and choosing tiles from different boxes, in order to avoid placing tiles with identical graphics adjacent to each other.
- La diversité graphique et la variété de tonalités naturelle des carreaux caractérisent cette série. Il est recommandé de mélanger les carreaux de différentes boîtes au cours de la pose et de les choisir dans différents colis pour éviter que les mêmes dessins ne se trouvent côte à côte.
- Die unterschiedlichen Maserungen und der natürlichen Farbspiel sind gewollten Eigenschaften dieser Serie. Bei der Verlegung es wird empfohlen Fliesen aus verschiedenen Kartons zu mischen.



44,4x89,4 cm R . 17<sup>3/4</sup>"x35<sup>7/8</sup>" R



30,8x61,5 cm N . 12"x24" N  
30,8x61,5 cm S . 12"x24" S

## bianco



61,5x61,5 cm 24"x24"	<b>N</b>
61,0x61,0 cm 24"x24"	<b>R</b>
45,5x45,5 cm 18 <sup>1/4</sup> "x18 <sup>1/4</sup> "	<b>N</b>
44,4x89,4 cm 17 <sup>3/4</sup> "x35 <sup>7/8</sup> "	<b>R</b>
30,8x61,5 cm 12"x24"	<b>N</b>

## grigio



61,5x61,5 cm 24"x24"	<b>N</b>
61,5x61,5 cm 24"x24" FP2	<b>N</b>
61,0x61,0 cm 24"x24"	<b>R</b>
61,0x61,0 cm 24"x24" FP2	<b>R</b>
45,5x45,5 cm 18 <sup>1/4</sup> "x18 <sup>1/4</sup> "	<b>N</b>
44,4x89,4 cm 17 <sup>3/4</sup> "x35 <sup>7/8</sup> "	<b>R</b>
30,8x61,5 cm 12"x24"	<b>N</b>
30,8x61,5 cm 12"x24" <b>R11</b>	<b>S</b>

## antracite



61,5x61,5 cm 24"x24"	<b>N</b>
61,5x61,5 cm 24"x24" FP2	<b>N</b>
61,0x61,0 cm 24"x24"	<b>R</b>
61,0x61,0 cm 24"x24" FP2	<b>R</b>
45,5x45,5 cm 18 <sup>1/4</sup> "x18 <sup>1/4</sup> "	<b>N</b>
44,4x89,4 cm 17 <sup>3/4</sup> "x35 <sup>7/8</sup> "	<b>R</b>
30,8x61,5 cm 12"x24"	<b>N</b>
30,8x61,5 cm 12"x24" <b>R11</b>	<b>S</b>

# technika

sviluppo grafico . design development

beige

61,0x61,0 cm R . 24"x24" R



taupe

30,8x61,5 cm N . 12"x24" N





technika

44,4x89,4 cm R .  $17\frac{3}{4}'' \times 35\frac{7}{8}''$  R

bianco



61,5x61,5 cm N .  $24'' \times 24''$  N

grigio



## antracite

45,5x45,5 cm N . 18<sup>1/4</sup>"x18<sup>1/4</sup>" N

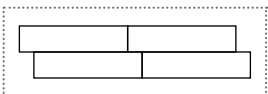

- Onde evitare problemi di planarità, per tutti i formati rettangolari si consiglia la posa sfalsata irregolare del prodotto come da schema.
- Irregular offset installation is advisable in the case of rectangular shaped products, to avoid problems associated with planarity. (See drawing).
- Pour tous les formats rectangulaires on conseille une pose décalée irrégulière afin d'éviter problèmes de planéité. (Observer le dessin).
- Um Planaritätsprobleme zu vermeiden, wird für die Rechteckischen Formate eine Eindrittelverlegung empfohlen, laut Skizze.

pezzi speciali - special pieces - pièces spéciales - formteile

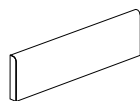

**battiscopa**   
7,5x61,5 cm 3"x24"  
beige  
taupe  
bianco  
grigio  
antracite



**gradino costa retta**  
34x61,5x4 cm 13"x24"x2"  
beige  
taupe  
bianco  
grigio  
antracite

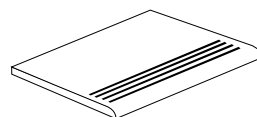

**step**  
30,8x61,5 cm 12"x24"  
beige  
taupe  
bianco  
grigio  
antracite



**vista frontale**  
angolare costa retta 34x34x4 cm 13"x13"x2"  
beige  
taupe  
bianco  
grigio  
antracite

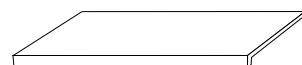
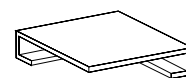

**elemento "L"**  
30x61,5x5 cm 12"x24"x2"  
grigio  
antracite

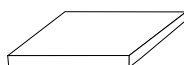

**angolare elemento "L"**  
30x30x5 cm 12"x12"x2"  
grigio  
antracite

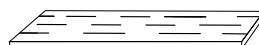

**griglia**  
20x61,0 cm 8"x24" R   
grigio  
antracite

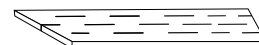

**angolo SX**  
griglia angolo 20x61,0 cm 8"x24" R   
grigio  
antracite

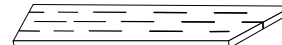

**angolo DX**  
grigio  
antracite

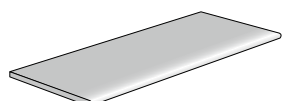

**round lineare**  
30x61,5 cm 18"x24"  
grigio  
antracite

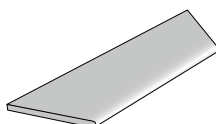

**angolo SX**  
round angolare 30x61,5 cm 18"x24"  
grigio  
antracite

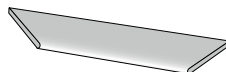

**angolo DX**  
grigio  
antracite

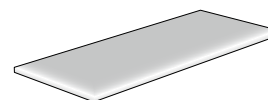

**angolo SX**  
angolo bordo toro 30x61,5 cm 18"x24"  
grigio  
antracite

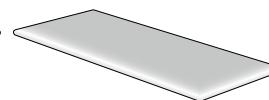

**angolo DX**  
grigio  
antracite

FP2 pezzi speciali - special pieces - pièces spéciales - formteile

Note - Notes - Notes - Anmerkungen

I battiscopa vengono venduti a ml e a scatola completa. I gradini e gli angolari vengono venduti a pz e solo su ordinazione (tempo minimo di consegna 20 gg lavorativi dall'ordine).  
The skirting tiles are sold by linear meter and in complete boxes. The steps and corner pieces are sold by the part and only on request (minimum delivery time 20 working days from date of order).  
Les plinthes sont vendues au mètre linéaire et par boîte complète. Les marches et les angles sont vendus à la pièce et uniquement sur commande (délai minimum de livraison 20 jours ouvrés à partir de la commande).  
Preis der Sockelleisten ist pro lfm zu verstehen. Wird nur auf vollen Kartons verkauft. Stufen und Stufenecken werden nur auf Bestellung produziert (Lieferzeit mindestens 20 Arbeitstagen ab Auftragserteilung).  
Preis ist pro Stück zu verstehen. Bestellungen auch Stückweise möglich.

tabella pesi ed imballi - sizes weight and packaging - mesures poids et emballages - tabelle der gewichte und verpackungen

formati / sizes / tailles / formate	pz. x box	mq. x box	kg. x box	box x pal.	mq. x pal.	kg. x pal.
61,5x61,5 cm 24"x24" (naturale)	4	1,51	34,00	30	45,30	1020
61,5x61,5 cm 24"x24" FP2 (naturale)	2	0,76	35,00	30	22,80	1050
61,0x61,0 cm 24"x24" (rettificato)	4	1,49	33,60	30	44,70	1000
45,5x45,5 cm 18 <sup>1</sup> / <sub>4</sub> "x18 <sup>1</sup> / <sub>4</sub> " (naturale)	7	1,45	28,20	44	63,80	1260
44,4x89,4 cm 17 <sup>3</sup> / <sub>4</sub> "x35 <sup>7</sup> / <sub>8</sub> " (rettificato)	3	1,19	26,20	32	38,08	850
30,8x61,5 cm 12"x24" (naturale)	7	1,32	26,80	40	52,80	1100
30,8x61,5 cm 12"x24" (strutturato)	7	1,32	26,80	40	52,80	1100
7,5x61,5 cm 3"x24" battiscopa	12	7,38/ml	14,50	80	590,40/ml	1180









## terraforte

Una proposta moderna che trova ispirazione nei colori delle terre della tradizione mediterranea evolvendosi verso un gusto attuale e raffinato. “Terraforte” si lega all’ Etruria ed alla Provenza rileggendo il passato di luoghi antichi traboccanti di storia, riportandolo però alle esigenze delle nostre architetture.

Mediterranean and homeland traditions inspire a modern proposal, that moves to a contemporary smart and fine taste. Terraforte collection takes inspiration from the rich in history Etruria and Provence regions, being related with our modern architectural design.







terraforte

dorato 15x30 cm N . 6"x12" N

# terraforte

Impasto Colorato  
Colored Body  
Masse Colorée  
Durchgefärbt



R10

HD

30,8x61,5 cm  
12"x24"

15x30 cm  
6"x12"

N

Naturale - Natural



30,8x61,5 cm N . 12"x24" N



15x30 cm N . 6"x12" N

dorato



30,8x61,5 cm 12"x24"

N

15x30 cm 6"x12"

N

grigio

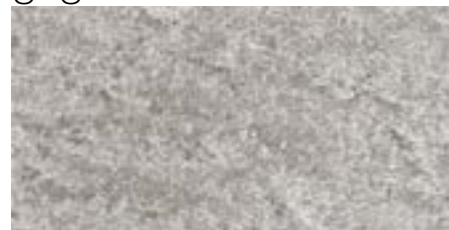

30,8x61,5 cm 12"x24"

N

15x30 cm 6"x12"

N

cuoio

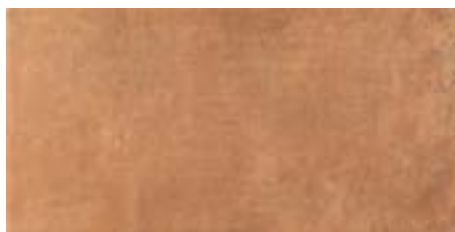

15x30 cm 6"x12"

N

ruggine



15x30 cm 6"x12"

N

V2

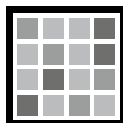

MODERATE

- La diversità di grafica e la naturale stonizzazione delle piastrelle costituiscono la caratteristica propria di questa serie. Si consiglia di miscelare le varie scatole durante la posa e di scegliere le piastrelle da diversi colli per evitare il ripetersi della stessa grafica accostata.
- The different graphics and the natural shading of each tile are intentional characteristics of this range. When laying tiles, we recommend mixing the various boxes and choosing tiles from different boxes, in order to avoid placing tiles with identical graphics adjacent to each other.
- La diversité graphique et la variété de tonalités naturelle des carreaux caractérisent cette série. Il est recommandé de mélanger les carreaux de différentes boîtes au cours de la pose et de les choisir dans différents colis pour éviter que les mêmes dessins ne se trouvent côte à côte.
- Die unterschiedlichen Maserungen und der natürlichen Farbspiel sind gewollten Eigenschaften dieser Serie. Bei der Verlegung es wird empfohlen Fliesen aus verschiedenen Kartons zu mischen.



terraforte

sviluppo grafico . design development

15x30 cm N . 6"x12" N

dorato



15x30 cm N . 6"x12" N

grigio





# terraforte

sviluppo grafico . design development

cuoio

15x30 cm N . 6"x12" N



ruggine

15x30 cm N . 6"x12" N



muretto 3D

bianco



30,8x61,5 cm 12"x24"



dorato



30,8x61,5 cm 12"x24"



grigio



30,8x61,5 cm 12"x24"



pezzi speciali - special pieces - pièces spéciales - formteile

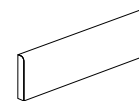

battiscopa   
7,5x30 cm 3"x12"

dorato  
cuoio  
grigio  
ruggine



elemento "L"  
15x30x4 cm 6"x12"x1<sup>3</sup>/<sub>4</sub>"

dorato  
cuoio  
grigio  
ruggine

Note - Notes - Notes - Anmerkungen

I battiscopa vengono venduti a ml e a scatola completa. I gradini e gli angolari vengono venduti a pz e solo su ordinazione (tempo minimo di consegna 20 gg lavorativi dall'ordine).  
The skirting tiles are sold by linear meter and in complete boxes. The steps and corner pieces are sold by the part and only on request (minimum delivery time 20 working days from date of order).  
Les plinthes sont vendues au mètre linéaire et par boîte complète. Les marches et les angles sont vendus à la pièce et uniquement sur commande (délai minimum de livraison 20 jours ouvrés à partir de la commande).  
Preis der Sockelleisten ist pro lfm zu verstehen. Wird nur auf vollen Kartons verkauft. Stufen und Stufenecken werden nur auf Bestellung produziert (Lieferzeit mindestens 20 Arbeitstagen ab Auftragserteilung).  
Preis ist pro Stück zu verstehen. Bestellungen auch Stückweise möglich.

tabella pesi ed imballi - sizes weight and packaging - mesures poids et emballages - tabelle der gewichte und verpackungen

formati / sizes / tailles / formate	pz. x box	mq. x box	kg. x box	box x pal.	mq. x pal.	kg. x pal.
30,8x61,5 cm 12"x24" (naturale)	7	1,32	26,80	40	52,80	1100
15x30 cm 6"x12" (naturale)	32	1,44	25,60	60	86,40	1550
7,5x30 cm 3"x12" battiscopa	36	10,80/ml	14,50	68	734,40/ml	990

- Onde evitare problemi di planarità, per tutti i formati rettangolari si consiglia la posa sfalsata irregolare del prodotto come da schema.
- Irregular offset installation is advisable in the case of rectangular shaped products, to avoid problems associated with planarity. (See drawing).
- Pour tous les formats rectangulaires on conseille une pose décalée irrégulière afin d'éviter problèmes de planéité. (Observer le dessin).
- Um Planaritätsprobleme zu vermeiden, wird für die Rechteckischen Formate eine Eindrittelverlegung empfohlen, laut Skizze.

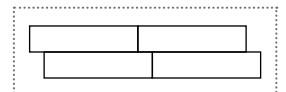









## bryce

Una cromia superficiale irregolare, intensa e d'effetto esalta un prodotto di carattere, impreziosito da un'alternanza cromatica decisa ed esclusiva.

La storica naturalezza della pietra trova vigore nelle sfumature e nelle naturali variazioni di colore che determinano giochi di luce irregolari.

An irregular surface decoration, rich and snappy, enhances a distinguished product, with precious, exclusive and deep chromatic variations.

The natural beauty of the stone gets improved by natural and irregular shade variations.







bryce

taupe 61,0x61,0 cm R . 24"x24" R





# bryce

Impasto Colorato  
Colored Body  
Masse Colorée  
Durchgefärbt



30,8x61,5 cm  
12"x24"

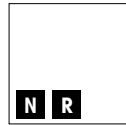

61,5x61,5 cm N . 24"x24" N  
61,0x61,0 cm R . 24"x24" R



30,8x61,5 cm N . 12"x24" N  
30,4x61,0 cm R . 12"x24" R



44,4x89,4 cm R . 17<sup>3/4</sup>"x35<sup>7/8</sup>" R

**R** Rettificato - Rectified

**N** Naturale - Natural

white



61,5x61,5 cm 24"x24"	<b>N</b>
61,0x61,0 cm 24"x24"	<b>R</b>
44,4,x89,4 cm 17 <sup>3/4</sup> "x35 <sup>7/8</sup> "	<b>R</b>
30,8x61,5 cm 12"x24"	<b>N</b>
30,4x61,0 cm 12"x24"	<b>R</b>

taupe



61,5x61,5 cm 24"x24"	<b>N</b>
61,0x61,0 cm 24"x24"	<b>R</b>
44,4,x89,4 cm 17 <sup>3/4</sup> "x35 <sup>7/8</sup> "	<b>R</b>
30,8x61,5 cm 12"x24"	<b>N</b>
30,4x61,0 cm 12"x24"	<b>R</b>

grey



61,5x61,5 cm 24"x24"	<b>N</b>
61,0x61,0 cm 24"x24"	<b>R</b>
44,4,x89,4 cm 17 <sup>3/4</sup> "x35 <sup>7/8</sup> "	<b>R</b>
30,8x61,5 cm 12"x24"	<b>N</b>
30,4x61,0 cm 12"x24"	<b>R</b>

**V2**

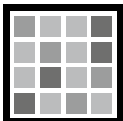

**MODERATE**

- La diversità di grafica e la naturale stonizzazione delle piastrelle costituiscono la caratteristica propria di questa serie. Si consiglia di miscelare le varie scatole durante la posa e di scegliere le piastrelle da diversi colli per evitare il ripetersi della stessa grafica accostata.
- The different graphics and the natural shading of each tile are intentional characteristics of this range. When laying tiles, we recommend mixing the various boxes and choosing tiles from different boxes, in order to avoid placing tiles with identical graphics adjacent to each other.
- La diversité graphique et la variété de tonalités naturelle des carreaux caractérisent cette série. Il est recommandé de mélanger les carreaux de différentes boîtes au cours de la pose et de les choisir dans différents colis pour éviter que les mêmes dessins ne se trouvent côte à côte.
- Die unterschiedlichen Maserungen und der natürlichen Farbspiel sind gewollten Eigenschaften dieser Serie. Bei der Verlegung es wird empfohlen Fliesen aus verschiedenen Kartons zu mischen.

bryce

sviluppo grafico . design development

30,4x61,0 cm R . 12"x24" R

white



61,5x61,5 cm N . 24"x24" N

grey



taupe

30,8x61,5 cm N . 12"x24" N



decori - decors - décors - dekors

mosaico listelli 

white



30,2x61,0 cm 12"x24"

**R**

taupe



30,2x61,0 cm 12"x24"

**R**

grey



30,2x61,0 cm 12"x24"

**R**



## pezzi speciali - special pieces - pièces spéciales - formteile



battiscopa   
7,5x61,5 cm 3"x24"  
white  
grey  
taupe



gradino costa retta  
34x61,5x4 cm 13"x24"x2"  
white  
grey  
taupe

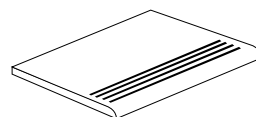

step  
30,8x61,5 cm 12"x24"  
white  
grey  
taupe



vista frontale  
angolare costa retta 34x34x4 cm 13"x13"x2"  
white  
grey  
taupe

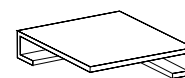

vista dal retro

Note - Notes - Notes - Anmerkungen

I battiscopa vengono venduti a ml e a scatola completa. I gradini e gli angolari vengono venduti a pz e solo su ordinazione (tempo minimo di consegna 20 gg lavorativi dall'ordine).  
The skirting tiles are sold by linear meter and in complete boxes. The steps and corner pieces are sold by the part and only on request (minimum delivery time 20 working days from date of order).  
Les plinthes sont vendues au mètre linéaire et par boîte complète. Les marches et les angles sont vendus à la pièce et uniquement sur commande (délai minimum de livraison 20 jours ouvrés à partir de la commande).  
Preis der Sockelleisten ist pro lfm zu verstehen. Wird nur auf vollen Kartons verkauft. Stufen und Stufenecken werden nur auf Bestellung produziert (Lieferzeit mindestens 20 Arbeitstagen ab Auftragserteilung).  
Preis ist pro Stück zu verstehen. Bestellungen auch Stückweise möglich.

## tabella pesi ed imballi - sizes weight and packaging - mesures poids et emballages - tabelle der gewichte und verpackungen

formati / sizes / tailles / formate	pz. x box	mq. x box	kg. x box	box x pal.	mq. x pal.	kg. x pal.
61,5x61,5 cm 24"x24" (naturale)	4	1,51	34,00	30	45,30	1020
61,0x61,0 cm 24"x24" (rettificato)	4	1,49	33,60	30	44,70	1000
44,4x89,4 cm 17 <sup>3/4</sup> "x35 <sup>7/8</sup> " (rettificato)	3	1,19	26,20	32	38,08	850
30,8x61,5 cm 12"x24" (naturale)	7	1,32	26,80	40	52,80	1100
30,4x61,0 cm 12"x24" (rettificato)	7	1,30	26,50	40	52,00	1060
7,5x61,5 cm 3"x24" battiscopa	12	7,38/ml	14,50	80	590,40/ml	1180

- Onde evitare problemi di planarità, per tutti i formati rettangolari si consiglia la posa sfalsata irregolare del prodotto come da schema.
- Irregular offset installation is advisable in the case of rectangular shaped products, to avoid problems associated with planarity. (See drawing).
- Pour tous les formats rectangulaires on conseille une pose décalée irrégulière afin d'éviter problèmes de planéité. (Observer le dessin).
- Um Planaritätsprobleme zu vermeiden, wird für die Rechteckischen Formate eine Eindrittelverlegung empfohlen, laut Skizze.

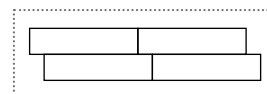





be\_marble  
astra  
olimpya

Ovvero l'esaltazione del marmo che storicamente avvolge lo spazio attraverso sensazioni visive e tattili sorprendenti. Tenui, leggere, raffinate venature creano eleganti movimenti cromatici superficiali che si fondono con l'intima classicità del prodotto per un risultato estetico straordinario.

The magnification of the marble, that involves all senses. The melting of soft, fine and slight veins leads to an extraordinary elegant and classic effect.





be\_marble

botticino almond 75x75 cm R . 30"x30" R - 37,5x75 cm R . 15"x30" R



# be\_marble

Impasto Colorato  
Colored Body  
Masse Colorée  
Durchgefärbt



R10

HD



75x75 cm R . 30"x30" R

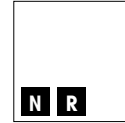

61,5x61,5 cm N . 24"x24" N  
61,0x61,0 cm R . 24"x24" R



37,5x75 cm R . 15"x30" R

**R** Rettificato - Rectified

**N** Naturale - Natural

## botticino almond



75x75 cm 30"x30" **R**

61,5x61,5 cm 24"x24" **N**

61,0x61,0 cm 24"x24" **R**

37,5x75 cm 15"x30" **R**

## calacatta white

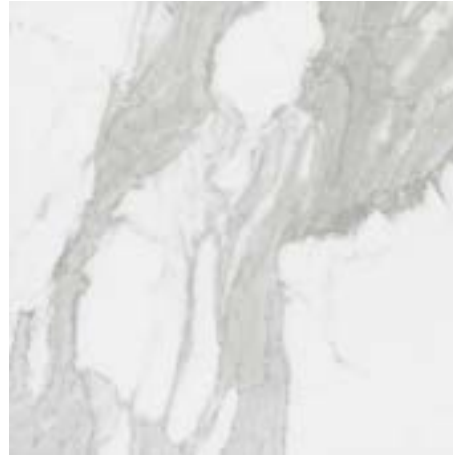

75x75 cm 30"x30" **R**

61,5x61,5 cm 24"x24" **N**

61,0x61,0 cm 24"x24" **R**

37,5x75 cm 15"x30" **R**



## V2

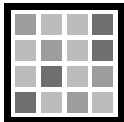

MODERATE

- La diversità di grafica e la naturale stonizzazione delle piastrelle costituiscono la caratteristica propria di questa serie. Si consiglia di miscelare le varie scatole durante la posa e di scegliere le piastrelle da diversi colli per evitare il ripetersi della stessa grafica accostata.
- The different graphics and the natural shading of each tile are intentional characteristics of this range. When laying tiles, we recommend mixing the various boxes and choosing tiles from different boxes, in order to avoid placing tiles with identical graphics adjacent to each other.
- La diversité graphique et la variété de tonalités naturelle des carreaux caractérisent cette série. Il est recommandé de mélanger les carreaux de différentes boîtes au cours de la pose et de les choisir dans différents colis pour éviter que les mêmes dessins ne se trouvent côte à côte.
- Die unterschiedlichen Maserungen und der natürlichen Farbspiel sind gewollten Eigenschaften dieser Serie. Bei der Verlegung es wird empfohlen Fliesen aus verschiedenen Kartons zu mischen.





calacatta white 37,5x75 cm R . 15"x30" R

be\_marble

sviluppo grafico . design development

botticino almond

37,5x75 cm R . 15"x30" R





calacatta white

61,5x61,5 cm N . 24"x24" N

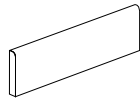

pezzi speciali - special pieces - pièces spéciales - formteile



**battiscopa**  **N**  
7,5x61,5 cm N 3"x24" N  
calacatta bianco  
botticino almond

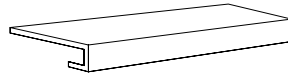

**gradino costa retta** **N**  
34x61,5x4 cm N 13"x24"x2" N  
calacatta bianco  
botticino almond

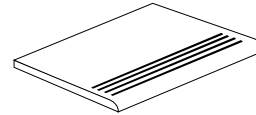

**step** **N**  
30,8x61,5 cm N 12"x24" N  
calacatta bianco  
botticino almond

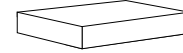

**vista frontale** **N**  
angolare costa retta 34x34x4 cm N 13"x13"x2" N  
calacatta bianco  
botticino almond

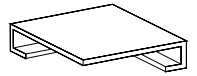

**vista dal retro** **N**

Note - Notes - Notes - Anmerkungen

I battiscopa vengono venduti a ml e a scatola completa. I gradini e gli angolari vengono venduti a pz e solo su ordinazione (tempo minimo di consegna 20 gg lavorativi dall'ordine).  
The skirting tiles are sold by linear meter and in complete boxes. The steps and corner pieces are sold by the part and only on request (minimum delivery time 20 working days from date of order).  
Les plinthes sont vendues au mètre linéaire et par boîte complète. Les marches et les angles sont vendus à la pièce et uniquement sur commande (délai minimum de livraison 20 jours ouvrés à partir de la commande).  
Preis der Sockelleisten ist pro lfm zu verstehen. Wird nur auf vollen Kartons verkauft. Stufen und Stufenecken werden nur auf Bestellung produziert (Lieferzeit mindestens 20 Arbeitstagen ab Auftragserteilung).  
Preis ist pro Stück zu verstehen. Bestellungen auch Stückweise möglich.

tabella pesi ed imballi - sizes weight and packaging - mesures poids et emballages - tabelle der gewichte und verpackungen

formati / sizes / tailles / formate	pz. x box	mq. x box	kg. x box	box x pal.	mq. x pal.	kg. x pal.
<b>75x75 cm 30"x30"</b> (rettificato)	2	1,13	26,00	45	50,85	1170
<b>61,5x61,5 cm 24"x24"</b> (naturale)	4	1,51	34,00	30	45,30	1020
<b>61,0x61,0 cm 24"x24"</b> (rettificato)	4	1,49	33,60	30	44,70	1000
<b>37,5x75 cm 30"x30"</b> (rettificato)	4	1,13	26,00	54	61,02	1400
<b>7,5x61,5 cm 3"x24"</b> <b>battiscopa</b> (naturale)	12	7,38/ml	14,50	80	590,40/ml	1180

- Onde evitare problemi di planarità, per tutti i formati rettangolari si consiglia la posa sfalsata irregolare del prodotto come da schema.
- Irregular offset installation is advisable in the case of rectangular shaped products, to avoid problems associated with planarity. (See drawing).
- Pour tous les formats rectangulaires on conseille une pose décalée irrégulière afin d'éviter problèmes de planéité. (Observer le dessin).
- Um Planaritätsprobleme zu vermeiden, wird für die Rechteckischen Formate eine Eindrittelverlegung empfohlen, laut Skizze.

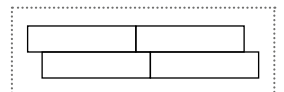



# astra

Impasto Colorato  
Colored Body  
Masse Colorée  
Durchgefärbt



R10

HD

**R**

Rettificato - Rectified

**N**

Naturale - Natural

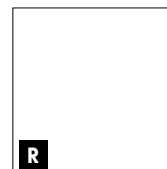

75x75 cm R . 30"x30" R

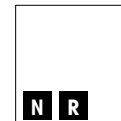

61,5x61,5 cm N . 24"x24" N

61,0x61,0 cm R . 24"x24" R

## bianco



75x75 cm 30"x30"

**R**

61,5x61,5 cm 24"x24"

**N**

61,0x61,0 cm 24"x24"

**R**

## grigio



75x75 cm 30"x30"

**R**

61,5x61,5 cm 24"x24"

**N**

61,0x61,0 cm 24"x24"

**R**

## beige



75x75 cm 30"x30"

**R**

61,5x61,5 cm 24"x24"

**N**

61,0x61,0 cm 24"x24"

**R**

75x75 cm R . 30"x30" R

bianco



61,5x61,5 cm N . 24"x24" N

grigio



# astra

sviluppo grafico . design development

## beige

61,0x61,0 cm R . 24"x24" R



### V2

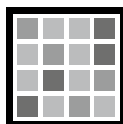



**MODERATE**

- La diversità di grafica e la naturale stonizzazione delle piastrelle costituiscono la caratteristica propria di questa serie. Si consiglia di miscelare le varie scatole durante la posa e di scegliere le piastrelle da diversi colli per evitare il ripetersi della stessa grafica accostata.
- The different graphics and the natural shading of each tile are intentional characteristics of this range. When laying tiles, we recommend mixing the various boxes and choosing tiles from different boxes, in order to avoid placing tiles with identical graphics adjacent to each other.
- La diversité graphique et la variété de tonalités naturelle des carreaux caractérisent cette série. Il est recommandé de mélanger les carreaux de différentes boîtes au cours de la pose et de les choisir dans différents colis pour éviter que les mêmes dessins ne se trouvent côte à côte.
- Die unterschiedlichen Maserungen und der natürlichen Farbspiel sind gewollten Eigenschaften dieser Serie. Bei der Verlegung es wird empfohlen Fliesen aus verschiedenen Kartons zu mischen.

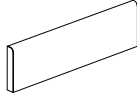

pezzi speciali - special pieces - pièces spéciales - formteile



battiscopa  **N**  
7,5x61,5 cm N 3"x24" N  
bianco  
grigio  
beige

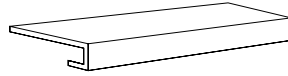

gradino costa retta **N**  
34x61,5x4 cm N 13"x24"x2" N  
bianco  
grigio  
beige

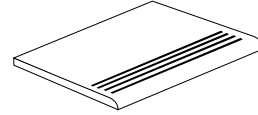

step **N**  
30,8x61,5 cm 12"x24"  
bianco  
grigio  
beige

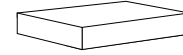

vista frontale **N**  
angolare costa retta 34x34x4 cm N 13"x13"x2" N  
bianco  
grigio  
beige

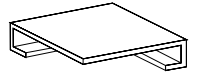

vista dal retro **N**

Note - Notes - Notes - Anmerkungen

I battiscopa vengono venduti a ml e a scatola completa. I gradini e gli angolari vengono venduti a pz e solo su ordinazione (tempo minimo di consegna 20 gg lavorativi dall'ordine).  
The skirting tiles are sold by linear meter and in complete boxes. The steps and corner pieces are sold by the part and only on request (minimum delivery time 20 working days from date of order).  
Les plinthes sont vendues au mètre linéaire et par boîte complète. Les marches et les angles sont vendus à la pièce et uniquement sur commande (délai minimum de livraison 20 jours ouvrés à partir de la commande).  
Preis der Sockelleisten ist pro lfm zu verstehen. Wird nur auf vollen Kartons verkauft. Stufen und Stufenecken werden nur auf Bestellung produziert (Lieferzeit mindestens 20 Arbeitstagen ab Auftragserteilung).  
Preis ist pro Stück zu verstehen. Bestellungen auch Stückweise möglich.

tabella pesi ed imballi - sizes weight and packaging - mesures poids et emballages - tabelle der gewichte und verpackungen

formati / sizes / tailles / formate	pz. x box	mq. x box	kg. x box	box x pal.	mq. x pal.	kg. x pal.
<b>75x75 cm 30"x30"</b> (rettificato)	2	1,13	26,00	45	50,85	1170
<b>61,5x61,5 cm 24"x24"</b> (naturale)	4	1,51	34,00	30	45,30	1020
<b>61,0x61,0 cm 24"x24"</b> (rettificato)	4	1,49	33,60	30	44,70	1000
<b>7,5x61,5 cm 3"x24"</b> battiscopa (naturale)	12	7,38/ml	14,50	80	590,40/ml	1180

# olimpya

Impasto Colorato  
Colored Body  
Masse Colorée  
Durchgefärbt



R10

HD

**R**

Rettificato - Rectified

**N**

Naturale - Natural

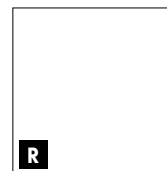

75x75 cm R . 30"x30" R

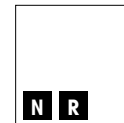

61,5x61,5 cm N . 24"x24" N  
61,0x61,0 cm R . 24"x24" R

almond



75x75 cm 30"x30"

**R**

61,5x61,5 cm 24"x24"

**N**

61,0x61,0 cm 24"x24"

**R**

beige



75x75 cm 30"x30"

**R**

61,5x61,5 cm 24"x24"

**N**

61,0x61,0 cm 24"x24"

**R**

**V2**

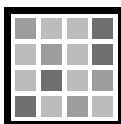

**MODERATE**

- La diversità di grafica e la naturale stonizzazione delle piastrelle costituiscono la caratteristica propria di questa serie. Si consiglia di miscelare le varie scatole durante la posa e di scegliere le piastrelle da diversi colli per evitare il ripetersi della stessa grafica accostata.
- The different graphics and the natural shading of each tile are intentional characteristics of this range. When laying tiles, we recommend mixing the various boxes and choosing tiles from different boxes, in order to avoid placing tiles with identical graphics adjacent to each other.
- La diversité graphique et la variété de tonalités naturelle des carreaux caractérisent cette série. Il est recommandé de mélanger les carreaux de différentes boîtes au cours de la pose et de les choisir dans différents colis pour éviter que les mêmes dessins ne se trouvent côte à côte.
- Die unterschiedlichen Maserungen und der natürlichen Farbspiel sind gewollten Eigenschaften dieser Serie. Bei der Verlegung es wird empfohlen Fliesen aus verschiedenen Kartons zu mischen.



beige 75x75 cm R . 30"x30" R



# olimpya

sviluppo grafico . design development

almond

75x75 cm R . 30"x30" R



beige

61,5x61,5 cm N . 24"x24" N



pezzi speciali - special pieces - pièces spéciales - formteile



battiscopa  **N**  
7,5x61,5 cm N 3"x24" N  
almond  
beige

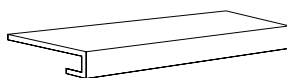

gradino costa retta **N**  
34x61,5x4 cm N 13"x24"x2" N  
almond  
beige

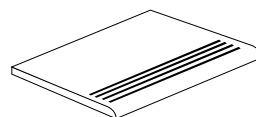

step **N**  
30,8x61,5 cm 12"x24"  
almond  
beige



vista frontale **N**  
angolare costa retta 34x34x4 cm N 13"x13"x2" N  
almond  
beige

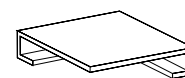

vista dal retro **N**

Note - Notes - Notes - Anmerkungen

I battiscopa vengono venduti a ml e a scatola completa. I gradini e gli angolari vengono venduti a pz e solo su ordinazione (tempo minimo di consegna 20 gg lavorativi dall'ordine).  
The skirting tiles are sold by linear meter and in complete boxes. The steps and corner pieces are sold by the part and only on request (minimum delivery time 20 working days from date of order).  
Les plinthes sont vendues au mètre linéaire et par boîte complète. Les marches et les angles sont vendus à la pièce et uniquement sur commande (délai minimum de livraison 20 jours ouvrés à partir de la commande).  
Preis der Sockelleisten ist pro lfm zu verstehen. Wird nur auf vollen Kartons verkauft. Stufen und Stufenecken werden nur auf Bestellung produziert (Lieferzeit mindestens 20 Arbeitstagen ab Auftragserteilung).  
Preis ist pro Stück zu verstehen. Bestellungen auch Stückweise möglich.

tabella pesi ed imballi - sizes weight and packaging - mesures poids et emballages - tabelle der gewichte und verpackungen

formati / sizes / tailles / formate	pz. x box	mq. x box	kg. x box	box x pal.	mq. x pal.	kg. x pal.
75x75 cm 30"x30" (rettificato)	2	1,13	26,00	45	50,85	1170
61,5x61,5 cm 24"x24" (naturale)	4	1,51	34,00	30	45,30	1020
61,0x61,0 cm 24"x24" (rettificato)	4	1,49	33,60	30	44,70	1000
7,5x61,5 cm 3"x24" battiscopa (naturale)	12	7,38/ml	14,50	80	590,40/ml	1180







# athena

Sintesi classica per un progetto che trasmette la naturalezza di un fascino antico come l'uomo: il marmo. Toni armonici ed universali di pietre pregiate tradizionalmente legate all'architettura. Uno stile unico che regala agli amanti del classico soluzioni moderne e creative.

The classical synthesis for a project that gives the truthfulness of a classic charm as old as the human being: The marble. Harmonic and universal tones from precious stones, always linked with architecture. A unique style that gives modern and creative solutions to classic style lovers.





athena

grigio 61,5x61,5 cm N . 24"x24" N



# athena

Impasto Colorato  
Colored Body  
Masse Colorée  
Durchgefärbt



**R10**

**HD**

30,8x61,5 cm  
12"x24"



75x75 cm R . 30"x30" R

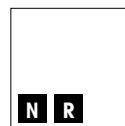

61,5x61,5 cm N . 24"x24" N  
61,0x61,0 cm R . 24"x24" R



44,4x89,4 cm R . 17<sup>3/4</sup>"x35<sup>7/8</sup>" R

**R** Rettificato - Rectified

**N** Naturale - Natural

## almond



75x75 cm 30"x30"	<b>R</b>
61,5x61,5 cm 24"x24"	<b>N</b>
61,0x61,0 cm 24"x24"	<b>R</b>
44,4,x89,4 cm 17 <sup>3/4</sup> "x35 <sup>7/8</sup> "	<b>R</b>
37,5x75 cm 15"x30"	<b>R</b>
30,8x61,5 cm 12"x24"	<b>N</b>
30,4x61,0 cm 12"x24"	<b>R</b>

## bianco



75x75 cm 30"x30"	<b>R</b>
61,5x61,5 cm 24"x24"	<b>N</b>
61,0x61,0 cm 24"x24"	<b>R</b>
44,4,x89,4 cm 17 <sup>3/4</sup> "x35 <sup>7/8</sup> "	<b>R</b>
37,5x75 cm 15"x30"	<b>R</b>
30,8x61,5 cm 12"x24"	<b>N</b>
30,4x61,0 cm 12"x24"	<b>R</b>



37,5x75 cm R . 15"x30" R



30,8x61,5 cm N . 12"x24" N  
30,4x61,0 cm R . 12"x24" R

grigio



75x75 cm 30"x30"	<b>R</b>
61,5x61,5 cm 24"x24"	<b>N</b>
61,0x61,0 cm 24"x24"	<b>R</b>
44,4,x89,4 cm 17 <sup>3</sup> / <sub>4</sub> "x35 <sup>7</sup> / <sub>8</sub> "	<b>R</b>
37,5x75 cm 15"x30"	<b>R</b>
30,8x61,5 cm 12"x24"	<b>N</b>
30,4x61,0 cm 12"x24"	<b>R</b>

nero



75x75 cm 30"x30"	<b>R</b>
61,5x61,5 cm 24"x24"	<b>N</b>
61,0x61,0 cm 24"x24"	<b>R</b>
44,4,x89,4 cm 17 <sup>3</sup> / <sub>4</sub> "x35 <sup>7</sup> / <sub>8</sub> "	<b>R</b>
37,5x75 cm 15"x30"	<b>R</b>
30,8x61,5 cm 12"x24"	<b>N</b>
30,4x61,0 cm 12"x24"	<b>R</b>

# athena

sviluppo grafico . design development

bianco

75x75 cm R . 30"x30" R



grigio

44,4x89,4 cm R . 17<sup>3/4</sup>"x35<sup>7/8</sup>" R





athena

37,5x75 cm R . 15"x30" R

nero



61,0x61,0 cm R . 24"x24" R

bianco e nero



# athena

sviluppo grafico . design development

## almond

30,4x61,0 cm R . 12"x24" R



**V2**

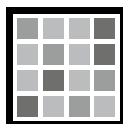

**MODERATE**

- La diversità di grafica e la naturale stonizzazione delle piastrelle costituiscono la caratteristica propria di questa serie. Si consiglia di miscelare le varie scatole durante la posa e di scegliere le piastrelle da diversi colli per evitare il ripetersi della stessa grafica accostata.
- The different graphics and the natural shading of each tile are intentional characteristics of this range. When laying tiles, we recommend mixing the various boxes and choosing tiles from different boxes, in order to avoid placing tiles with identical graphics adjacent to each other.
- La diversité graphique et la variété de tonalités naturelle des carreaux caractérisent cette série. Il est recommandé de mélanger les carreaux de différentes boîtes au cours de la pose et de les choisir dans différents colis pour éviter que les mêmes dessins ne se trouvent côte à côte.
- Die unterschiedlichen Maserungen und der natürlichen Farbspiel sind gewollten Eigenschaften dieser Serie. Bei der Verlegung es wird empfohlen Fliesen aus verschiedenen Kartons zu mischen.

## pezzi speciali - special pieces - pièces spéciales - formteile

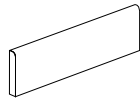

battiscopa  **N**  
7,5x61,5 cm N 3"x24" N  
almond  
bianco  
grigio  
nero

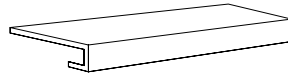

gradino costa retta **N**  
34x61,5x4 cm N 13"x24"x2" N  
almond  
bianco  
grigio  
nero

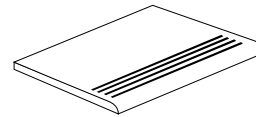

step **N**  
30,8x61,5 cm N 12"x24" N  
almond  
bianco  
grigio  
nero

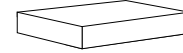

vista frontale **N**  
angolare costa retta 34x34x4 cm N 13"x13"x2" N  
almond  
bianco  
grigio  
nero

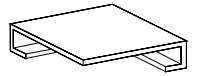

Note - Notes - Notes - Anmerkungen

I battiscopa vengono venduti a ml e a scatola completa. I gradini e gli angolari vengono venduti a pz e solo su ordinazione (tempo minimo di consegna 20 gg lavorativi dall'ordine).  
The skirting tiles are sold by linear meter and in complete boxes. The steps and corner pieces are sold by the part and only on request (minimum delivery time 20 working days from date of order).  
Les plinthes sont vendues au mètre linéaire et par boîte complète. Les marches et les angles sont vendus à la pièce et uniquement sur commande (délai minimum de livraison 20 jours ouvrés à partir de la commande).  
Preis der Sockelleisten ist pro lfm zu verstehen. Wird nur auf vollen Kartons verkauft. Stufen und Stufenecken werden nur auf Bestellung produziert (Lieferzeit mindestens 20 Arbeitstagen ab Auftragserteilung).  
Preis ist pro Stück zu verstehen. Bestellungen auch Stückweise möglich.

## tabella pesi ed imballi - sizes weight and packaging - mesures poids et emballages - tabelle der gewichte und verpackungen

formati / sizes / tailles / formate	pz. x box	mq. x box	kg. x box	box x pal.	mq. x pal.	kg. x pal.
75x75 cm 30"x30" (rettificato)	2	1,13	26,00	45	50,85	1170
61,5x61,5 cm 24"x24" (naturale)	4	1,51	34,00	30	45,30	1020
61,0x61,0 cm 24"x24" (rettificato)	4	1,49	33,60	30	44,70	1000
44,4x89,4 cm 17 <sup>3/4</sup> "x35 <sup>7/8</sup> " (rettificato)	3	1,19	26,20	32	38,08	850
37,5x75 cm 30"x30" (rettificato)	4	1,13	26,00	54	61,02	1400
30,8x61,5 cm 12"x24" (naturale)	7	1,32	26,80	40	52,80	1100
30,4x61,0 cm 12"x24" (rettificato)	7	1,30	26,50	40	52,00	1060
7,5x61,5 cm 3"x24" battiscopa (naturale)	12	7,38/ml	14,50	80	590,40/ml	1180

- Onde evitare problemi di planarità, per tutti i formati rettangolari si consiglia la posa sfalsata irregolare del prodotto come da schema.
- Irregular offset installation is advisable in the case of rectangular shaped products, to avoid problems associated with planarity. (See drawing).
- Pour tous les formats rectangulaires on conseille une pose décalée irrégulière afin d'éviter problèmes de planéité. (Observer le dessin).
- Um Planaritätsprobleme zu vermeiden, wird für die Rechteckischen Formate eine Eindrittelverlegung empfohlen, laut Skizze.

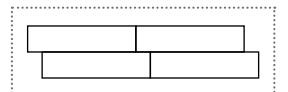







## north wind

Il vento del Nord passa attraverso i boschi e le foreste modificando profondamente l'aspetto del paesaggio, una storia fatta di tempo e pazienza. Da questa immagine prende spunto North Wind una collezione dal forte impatto grafico che presenta 5 essenze dai colori neutri. Una collezione che risponde alle esigenze contemporanee di uno stile coordinato fra interno e outdoor.

The north wind blowing through woods and forests deeply changes landscapes. This is the inspiration of North Wind collection. A strong graphic image made of 5 natural colors. North Wind: a collection that matches all contemporary needs, combining indoor and outdoor surfaces.









north wind

ivory 20x120 cm N . 8"x48" N

# north wind

Impasto Colorato  
Colored Body  
Masse Colorée  
Durchgefärbt

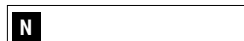

20x120 cm . 8"x48"

21,8x89,4 cm R . 8<sup>7/8</sup>"x35<sup>7/8</sup>" R

14,5x89,4 cm R . 5<sup>7/8</sup>"x35<sup>7/8</sup>" R

**R** Rettificato - Rectified

**N** Naturale - Natural

## ivory



20x120 cm 8"x48" **N**

21,8x89,4 cm 8<sup>7/8</sup>"x35<sup>7/8</sup>" **R**

14,5x89,4 cm 5<sup>7/8</sup>"x35<sup>7/8</sup>" **R**

## oak



20x120 cm 8"x48" **N**

21,8x89,4 cm 8<sup>7/8</sup>"x35<sup>7/8</sup>" **R**

14,5x89,4 cm 5<sup>7/8</sup>"x35<sup>7/8</sup>" **R**

## grey



20x120 cm 8"x48" **N**

21,8x89,4 cm 8<sup>7/8</sup>"x35<sup>7/8</sup>" **R**

14,5x89,4 cm 5<sup>7/8</sup>"x35<sup>7/8</sup>" **R**

14,5x89,4 cm 5<sup>7/8</sup>"x35<sup>7/8</sup>" **R11**

45x90 cm 18"x36" FP2 **N**

44,4x89 cm 17<sup>3/4</sup>"x35<sup>3/4</sup>" FP2 **R**

61,5x61,5 cm 24"x24" FP2 **N**

61,0x61,0 cm 24"x24" FP2 **R**

## brown



20x120 cm 8"x48" **N**

21,8x89,4 cm 8<sup>7/8</sup>"x35<sup>7/8</sup>" **R**

14,5x89,4 cm 5<sup>7/8</sup>"x35<sup>7/8</sup>" **R**

14,5x89,4 cm 5<sup>7/8</sup>"x35<sup>7/8</sup>" **R11**

45x90 cm 18"x36" FP2 **N**

44,4x89 cm 17<sup>3/4</sup>"x35<sup>3/4</sup>" FP2 **R**

61,5x61,5 cm 24"x24" FP2 **N**

61,0x61,0 cm 24"x24" FP2 **R**

## melange



20x120 cm 8"x48" **N**

21,8x89,4 cm 8<sup>7/8</sup>"x35<sup>7/8</sup>" **R**

14,5x89,4 cm 5<sup>7/8</sup>"x35<sup>7/8</sup>" **R**

14,5x89,4 cm 5<sup>7/8</sup>"x35<sup>7/8</sup>" **R11**

45x90 cm 18"x36" FP2 **N**

44,4x89 cm 17<sup>3/4</sup>"x35<sup>3/4</sup>" FP2 **R**

61,5x61,5 cm 24"x24" FP2 **N**

61,0x61,0 cm 24"x24" FP2 **R**

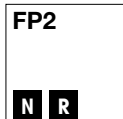

61,5x61,5 cm N . 24"x24" N  
61,0x61,0 cm R . 24"x24" R



45x90 cm N . 18"x36" N  
44,4x89 cm R . 17<sup>3/4</sup>"x35<sup>3/4</sup>" R

21,8x89,4 cm R . 8<sup>7/8</sup>"x35<sup>7/8</sup>" R - 14,5x89,4 cm R . 5<sup>7/8</sup>"x35<sup>7/8</sup>" R

melange



V3

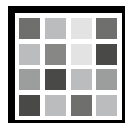

HIGH

- La diversità di grafica e la naturale stonizzazione delle piastrelle costituiscono la caratteristica propria di questa serie. Si consiglia di miscelare le varie scatole durante la posa e di scegliere le piastrelle da diversi colli per evitare il ripetersi della stessa grafica accostata.
- The different graphics and the natural shading of each tile are intentional characteristics of this range. When laying tiles, we recommend mixing the various boxes and choosing tiles from different boxes, in order to avoid placing tiles with identical graphics adjacent to each other.
- La diversité graphique et la variété de tonalités naturelle des carreaux caractérisent cette série. Il est recommandé de mélanger les carreaux de différentes boîtes au cours de la pose et de les choisir dans différents colis pour éviter que les mêmes dessins ne se trouvent côte à côte.
- Die unterschiedlichen Maserungen und der natürlichen Farbspiel sind gewollten Eigenschaften dieser Serie. Bei der Verlegung es wird empfohlen Fliesen aus verschiedenen Kartons zu mischen.



# north wind

---

decori - decors - décors - dekors

mosaico mix 36 tessere 5x5 

ivory/grey



30x30 cm 12"x12"

---

brown/oak

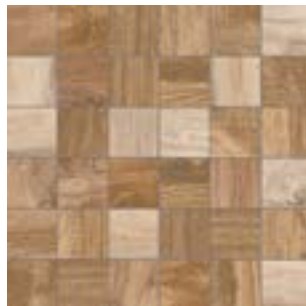

30x30 cm 12"x12"

---

stripe monocolore 18 tessere 5x10 

ivory



30x30 cm 12"x12"

---

grey



30x30 cm 12"x12"

---

melange

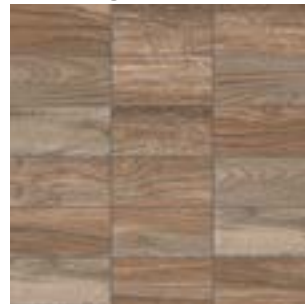

30x30 cm 12"x12"

---

stripe mix 18 tessere 5x10 

brown/oak



30x30 cm 12"x12"

---

## pezzi speciali - special pieces - pièces spéciales - formteile



battiscopa **R**   
7x89,4 cm  $2\frac{7}{8}'' \times 35\frac{7}{8}''$   
ivory  
grey  
oak  
brown  
melange

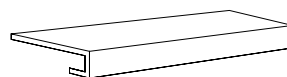

gradino costa retta   
34x61,5x4 cm  $13'' \times 24'' \times 2''$   
ivory  
grey  
oak  
brown  
melange



vista frontale  
angolare costa retta 34x34x4 cm  $13'' \times 13'' \times 2''$   
ivory  
grey  
oak  
brown  
melange

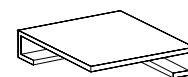

vista dal retro

## FP2 pezzi speciali - special pieces - pièces spéciales - formteile

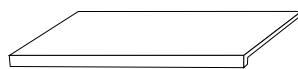

elemento "L"  
45x90x5 cm  $18'' \times 36'' \times 2''$   
30x61,5x5 cm  $12'' \times 24'' \times 2''$   
ivory  
grey  
oak  
brown  
melange



angolare elemento "L"  
45x45x5 cm  $18'' \times 18'' \times 2''$   
30x30x5 cm  $12'' \times 12'' \times 2''$   
ivory  
grey  
oak  
brown  
melange

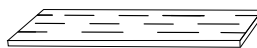

griglia **R**  
20x89 cm  $8'' \times 36''$  R **R**  
20x61,0 cm R  $8'' \times 24''$  R **R**  
ivory  
grey  
oak  
brown  
melange

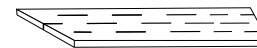

angolo SX  
griglia angolo 20x89 cm R  $8'' \times 35\frac{3}{4}''$  R **R**  
20x61,0 cm R  $8'' \times 24''$  R **R**  
ivory  
grey  
oak  
brown  
melange



angolo DX  
ivory  
grey  
oak  
brown  
melange

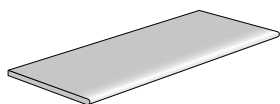

round lineare  
45x90 cm  $18'' \times 36''$   
30x61,5 cm  $12'' \times 24''$   
ivory  
grey  
oak  
brown  
melange

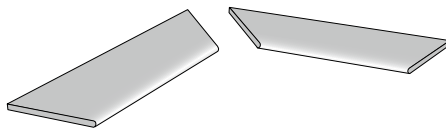

angolo SX  
round angolare 45x90 cm  $18'' \times 36''$   
30x61,5 cm  $12'' \times 24''$   
ivory  
grey  
oak  
brown  
melange

angolo DX  
ivory  
grey  
oak  
brown  
melange

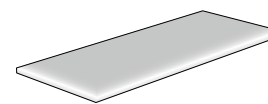

angolo SX  
angolo bordo toro 45x90 cm  $18'' \times 36''$   
30x61,5 cm  $12'' \times 24''$   
ivory  
grey  
oak  
brown  
melange

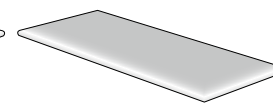

angolo DX  
ivory  
grey  
oak  
brown  
melange

Note - Notes - Notes - Anmerkungen

I battiscopa vengono venduti a ml e a scatola completa. I gradini e gli angolari vengono venduti a pz e solo su ordinazione (tempo minimo di consegna 20 gg lavorativi dall'ordine).  
The skirting tiles are sold by linear meter and in complete boxes. The steps and corner pieces are sold by the part and only on request (minimum delivery time 20 working days from date of order).  
Les plinthes sont vendues au mètre linéaire et par boîte complète. Les marches et les angles sont vendus à la pièce et uniquement sur commande (délai minimum de livraison 20 jours ouvrés à partir de la commande).  
Preis der Sockelleisten ist pro lfm zu verstehen. Wird nur auf vollen Kartons verkauft. Stufen und Stufenecken werden nur auf Bestellung produziert (Lieferzeit mindestens 20 Arbeitstagen ab Auftragserteilung).  
Preis ist pro Stück zu verstehen. Bestellungen auch Stückweise möglich.

## tabella pesi ed imballi - sizes weight and packaging - mesures poids et emballages - tabelle der gewichte und verpackungen

formati / sizes / tailles / formate	pz. x box	mq. x box	kg. x box	box x pal.	mq. x pal.	kg. x pal.
20x120 cm $8'' \times 48''$	4	0,97	21,11	36	34,92	780
21,8x89,4 cm $8\frac{7}{8}'' \times 35\frac{7}{8}''$ (rettificato)	5	0,97	21,50	60	58,20	1300
14,5x89,4 cm $5\frac{7}{8}'' \times 35\frac{7}{8}''$ (rettificato)	8	1,04	22,90	48	49,92	1100
14,5x89,4 cm $5\frac{7}{8}'' \times 35\frac{7}{8}''$ R11 (rettificato)	8	1,04	22,50	48	49,92	1100
45x90 cm $18'' \times 35\frac{3}{4}''$ FP2 (naturale)	2	0,81	36,50	27	21,87	1000
44,4x89 cm $17\frac{3}{4}'' \times 35\frac{7}{8}''$ FP2 (rettificato)	2	0,79	35,50	27	21,33	970
61,5x61,5 cm $24'' \times 24''$ FP2 (naturale)	2	0,76	35,00	30	22,80	1050
61,0x61,0 cm $24'' \times 24''$ FP2 (rettificato)	2	0,73	33,00	30	21,90	1000
7x89,4 cm $2\frac{7}{8}'' \times 35\frac{7}{8}''$ battiscopa (rettificato)	10	8,94/ml	13,80	36	321,84/ml	550

- Onde evitare problemi di planarità, per tutti i formati rettangolari si consiglia la posa sfalsata irregolare del prodotto come da schema.
- Irregular offset installation is advisable in the case of rectangular shaped products, to avoid problems associated with planarity. (See drawing).
- Pour tous les formats rectangulaires on conseille une pose décalée irrégulière afin d'éviter problèmes de planéité. (Observer le dessin).
- Um Planaritätsprobleme zu vermeiden, wird für die Rechteckischen Formate eine Eindrittelverlegung empfohlen, laut Skizze.

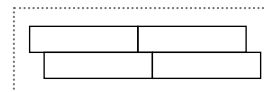







# nautika

Stupire attraverso i dettagli è l'obiettivo di questa linea di prodotti. La differenza estetica e qualitativa nei dettagli la si ottiene partendo da materie prime selezionate ma soprattutto da un costante impegno nello studio e nella ricerca, avente come termine di paragone la sorprendente didattica della natura. Superfici armoniche di legni che hanno il sapore del vissuto e che offrono sensazioni tattili e visive uniche ed esclusive per avvolgere meravigliosamente lo spazio architettonico.

Amazed by details. The goal of this collection. Details that distinguish both aesthetic and quality features, as a result of constant R&D efforts and the use of selected raw materials. Experienced wood effect surfaces giving warm and unique feeling, to characterize architectural design.





# nautika

beach 14,5x89,4 cm R . 5<sup>7/8</sup>"x35<sup>7/8</sup>" R - white 14,5x89,4 cm R . 5<sup>7/8</sup>"x35<sup>7/8</sup>" R  
white decoro mappa 14,5x89,4 cm R . 5<sup>7/8</sup>"x35<sup>7/8</sup>" R - white mosaico bacchetta 21,8x89,4 cm R . 8<sup>7/8</sup>"x35<sup>7/8</sup>" R







R10

HD

**R** Rettificato - Rectified

white



21,8x89,4 cm  $8\frac{7}{8}'' \times 35\frac{7}{8}''$

**R**

14,5x89,4 cm  $5\frac{7}{8}'' \times 35\frac{7}{8}''$

**R**

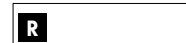

21,8x89,4 cm R .  $8\frac{7}{8}'' \times 35\frac{7}{8}''$  R

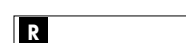

14,5x89,4 cm R .  $5\frac{7}{8}'' \times 35\frac{7}{8}''$  R

beach



21,8x89,4 cm  $8\frac{7}{8}'' \times 35\frac{7}{8}''$

**R**

14,5x89,4 cm  $5\frac{7}{8}'' \times 35\frac{7}{8}''$

**R**

**V3**

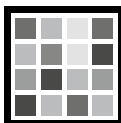

**HIGH**

- La diversità di grafica e la naturale stonizzazione delle piastrelle costituiscono la caratteristica propria di questa serie. Si consiglia di miscelare le varie scatole durante la posa e di scegliere le piastrelle da diversi colli per evitare il ripetersi della stessa grafica accostata.
- The different graphics and the natural shading of each tile are intentional characteristics of this range. When laying tiles, we recommend mixing the various boxes and choosing tiles from different boxes, in order to avoid placing tiles with identical graphics adjacent to each other.
- La diversité graphique et la variété de tonalités naturelle des carreaux caractérisent cette série. Il est recommandé de mélanger les carreaux de différentes boîtes au cours de la pose et de les choisir dans différents colis pour éviter que les mêmes dessins ne se trouvent côte à côte.
- Die unterschiedlichen Maserungen und der natürlichen Farbspiel sind gewollten Eigenschaften dieser Serie. Bei der Verlegung es wird empfohlen Fliesen aus verschiedenen Kartons zu mischen.

14,5x89,4 cm R . 5<sup>7</sup>/<sub>8</sub>"x35<sup>7</sup>/<sub>8</sub>" R - decoro Mappa 14,5x89,4 cm R . 5<sup>7</sup>/<sub>8</sub>"x35<sup>7</sup>/<sub>8</sub>" R

white



21,8x89,4 cm R . 8<sup>7</sup>/<sub>8</sub>"x35<sup>7</sup>/<sub>8</sub>" R - decoro Mappa 21,8x89,4 cm R . 8<sup>7</sup>/<sub>8</sub>"x35<sup>7</sup>/<sub>8</sub>" R

beach



# nautika

---

decori - decors - décors - dekors

mosaico bacchetta 13 bacchette 1,58x89,4 

white



21,8x89,4 cm 8<sup>7/8</sup>"x35<sup>7/8</sup>"

**R**

beach



21,8x89,4 cm 8<sup>7/8</sup>"x35<sup>7/8</sup>"

**R**

decoro mappa

white

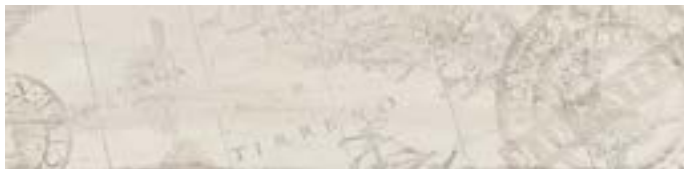

21,8x89,4 cm 8<sup>7/8</sup>"x35<sup>7/8</sup>"

**R**



beach



21,8x89,4 cm 8<sup>7/8</sup>"x35<sup>7/8</sup>"

**R**



white



14,5x89,4 cm 5<sup>7/8</sup>"x35<sup>7/8</sup>"

**R**



beach



14,5x89,4 cm 5<sup>7/8</sup>"x35<sup>7/8</sup>"



**R**



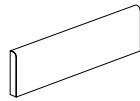

## pezzi speciali - special pieces - pièces spéciales - formteile



**battiscopa**    
**7x89,4 cm**  $2\frac{7}{8}'' \times 35\frac{7}{8}''$   
 white  
 beach



**gradino costa retta**   
**34x61,5x4 cm**  $13'' \times 24'' \times 2''$   
 white  
 beach

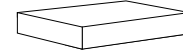

**vista frontale**  
**angolare costa retta** **34x34x4 cm**  $13'' \times 13'' \times 2''$   
 white  
 beach

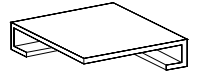

**vista dal retro**

Note - Notes - Notes - Anmerkungen

I battiscopa vengono venduti a ml e a scatola completa. I gradini e gli angolari vengono venduti a pz e solo su ordinazione (tempo minimo di consegna 20 gg lavorativi dall'ordine).  
 The skirting tiles are sold by linear meter and in complete boxes. The steps and corner pieces are sold by the part and only on request (minimum delivery time 20 working days from date of order).  
 Les plinthes sont vendues au mètre linéaire et par boîte complète. Les marches et les angles sont vendus à la pièce et uniquement sur commande (délai minimum de livraison 20 jours ouvrés à partir de la commande).  
 Preis der Sockelleisten ist pro lfm zu verstehen. Wird nur auf vollen Kartons verkauft. Stufen und Stufenecken werden nur auf Bestellung produziert (Lieferzeit mindestens 20 Arbeitstagen ab Auftragserteilung).  
 Preis ist pro Stück zu verstehen. Bestellungen auch Stückweise möglich.







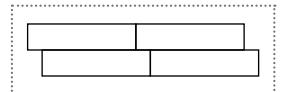





## tabella pesi ed imballi - sizes weight and packaging - mesures poids et emballages - tabelle der gewichte und verpackungen

formati / sizes / tailles / formate	pz. x box	mq. x box	kg. x box	box x pal.	mq. x pal.	kg. x pal.
<b>21,8x89,4 cm</b> $8\frac{7}{8}'' \times 35\frac{7}{8}''$ (rettificato)	5	0,97	21,50	60	58,20	1300
<b>14,5x89,4 cm</b> $5\frac{7}{8}'' \times 35\frac{7}{8}''$ (rettificato)	8	1,04	22,90	48	49,92	1100
<b>21,8x89,4 cm</b> $8\frac{7}{8}'' \times 35\frac{7}{8}''$ <b>decoro mappa</b> (rettificato)	5	0,97	21,50	60	58,20	1300
<b>14,5x89,4 cm</b> $5\frac{7}{8}'' \times 35\frac{7}{8}''$ <b>decoro mappa</b> (rettificato)	8	1,04	22,90	48	49,92	1100
<b>7x89,4 cm</b> $2\frac{7}{8}'' \times 35\frac{7}{8}''$ <b>battiscopa</b> (rettificato)	10	8,94/ml	13,80	36	321,84/ml	550

- Onde evitare problemi di planarità, per tutti i formati rettangolari si consiglia la posa sfalsata irregolare del prodotto come da schema.
- Irregular offset installation is advisable in the case of rectangular shaped products, to avoid problems associated with planarity. (See drawing).
- Pour tous les formats rectangulaires on conseille une pose décalée irrégulière afin d'éviter problèmes de planéité. (Observer le dessin).
- Um Planaritätsprobleme zu vermeiden, wird für die Rechteckischen Formate eine Eindrittelverlegung empfohlen, laut Skizze.



caratteristiche tecniche - technical characteristics -  
 caractéristiques techniques - technischen eigenschaften

	CARATTERISTICHE TECNICHE TECHNICAL CHARACTERISTICS CARACTÉRISTIQUES TECHNIQUES TECHNISCHE MERKMALE	NORMA DI RIFERIMENTO REFERENCE STANDARD NORME DE REFERENCE PRÜFMETHODE			VALORE RICHIESTO REQUIRED VALUE VALEUR REQUISE SOLLWERT		VALORE MEDIO TOSCOKER AV. TOSCOKER VALUE VALEUR MOYENNE TOSCOKER MITTLERER TOSCOKER-WERT
	DIMENSIONI DIMENSIONS DIMENSIONS ABMESSUNGEN	ISO 10545-2			CONFORME COMPLIANT CONFORME KONFORM		CONFORME COMPLIANT CONFORME KONFORM
	ASSORBIMENTO D'ACQUA WATER ABSORPTION ABSORPTION D'EAU WASSERAUFNAHME	ISO 10545-3			≤ 0,5 %		<0,4%
	RESISTENZA A FLESSIONE MODULUS OF RUPTURE RESISTANCE A LA FLEXION BIEGEFESTIGKEIT	ISO 10545-4			MODULUS OF RUPTURE R ≥35 N/MM <sup>2</sup> BREAKING STRENGTH S ≥1300 N		R>50 N/mm <sup>2</sup> S>2500 N
	DUREZZA SUPERFICIALE SCRATCH RESISTANCE DURETE SUPERFICIELLE KRATZFESTIGKEIT	ISO 10545-7			0 - V		IV
	DILATAZIONE TERMICA LINEARE LINEAR THERMAL EXPANSION DILATATION THERMIQUE LINEAIRE LINEARE WÄRMEAUSDEHNUNG	ISO 10545-8			=< 9x10 <sup>-5</sup> °C <sup>-1</sup>		6x10 <sup>-5</sup> °C <sup>-1</sup>
	RESISTENZA AGLI SBALZI TERMICI THERMAL SHOCK RESISTANCE RESISTANCE AUX ECARTS DE TEMPERATURE ITEMPERATURWECHSELBESTÄNDIGKEIT	ISO 10545-9			RESISTENTE RESISTANT RESISTANT BESTÄNDIG		RESISTENTE RESISTANT RESISTANT BESTÄNDIG
	RESISTENZA AL GELO FROST RESISTANCE RESISTANCE AU GEL FROSTBESTÄNDIGKEIT	ISO 10545-12			RESISTENTE RESISTANT RESISTANT BESTÄNDIG		RESISTENTE RESISTANT RESISTANT BESTÄNDIG
	RESISTENZA AGLI ACIDI ED ALLE BASI ACID AND ALKALI RESISTANCE RESISTANCE AUX ACIDES ET AUX BASES SÄURE- UND LAUGENBESTÄNDIGKEIT	ISO 10545-13			CLASS GB MIN.		LOW CONCENTRATION GLA HIGH CONCENTRATION GHA
	RESISTENZA ALL'ATTACCO CHIMICO CHEMICAL RESISTANCE RESISTANCE À L'ATTAQUE CHEMIQUE CHEMISCHE BESTÄNDIGKEIT	ISO 10545-13			CLASS GB MIN.		GA
	RESISTENZA ALLE MACCHIE STAIN RESISTANCE RESISTANCE AU TACHES FLECKENBESTÄNDIGKEIT	ISO 10545-14			CLASS 3 MIN.		5
	COEFFICIENTE DI ATTRITO (SCIVOLOSITÀ) FRICTION COEFFICIENT (SLIPPERINESS) COEFFICIENT DE FRICTION (GLISSEMENT) REIBUNGSKOEFFIZIENT (RUTSCHIGKEIT)	BCR - ITALIA DM DEL 14-06-89			ASTM - USA ASTM C1028		DIN - GERMANIA DIN 51130
		DRY RUBBER 0,62	WET RUBBER 0,51	DRY LEATHER 0,62	DRY NEOLYTHE 0,69	WET NEOLYTHE 0,62	R9-R12 ZH 1/571
THE PRODUCTS HAVING AN ABSORPTION < 0,5% ARE CLASSIFIED ACCORDING THE UNI CEN STANDARDS "FULLY VITRIFIED TILES" AND ACCORDING TO THE ASTM STANDARDS "IMPERVIOUS TILES"							

# simbologia - symbols - symboles - symbole

**Variatione di stonalizzazione.** La parola "stonalizzazione" è una denominazione con la quale si intende un passaggio di gradazioni cromatiche visibili e non armonizzabili. Indica la differenza di tono delle singole piastrelle come non omogenee tra di loro. In particolare sono state stabilite delle classi entro le quali sono classificate le diverse collezioni di piastrelle in gres porcellanato:

**Tonal variations.** By "tonal variations", we mean a series of chromatic gradations that are visible and not blendable. It indicates the difference of tone between single tiles that are not homogeneous with each other. In particular, we have defined classes for grouping the various porcelain stoneware tile collections.

**Variation du dénuancé.** Le mot "dénuancé" désigne un passage de dégradés de couleurs visibles non associables. Il indique la différence de tons pour tous les carreaux non homogènes. Nous avons notamment établi des catégories où sont classifiées les différentes collections de grès cérame porcelainé:

**Grad der Farbabweichungen.** Grad Veränderung im Farbton und/oder der Farbe zwischen den verschiedenen Teilen des gelegten Produktes: Minimum V1, Maximum V4.:

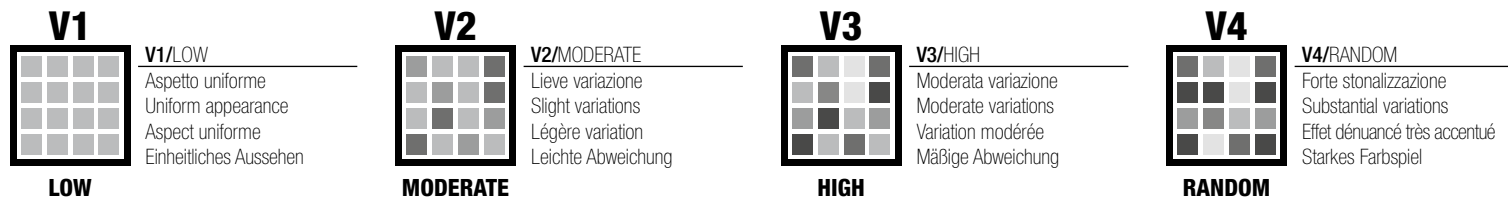

**HD**

- La stampa digitale offre per le serie HD la possibilità di illimitate riproduzioni grafiche ad alta definizione. Può creare immagini con innumerevoli variabili cromatiche e rappresentazioni grafiche multi facce.
- The digital print offers for the collections HD unlimited reproductions at high definition. It can create images with innumerable chromatic and graphic variables.
- L'émaillage à haute definition offre pour les collections HD une large variété de nuances et textures.
- Die Digitaltechnik bietet die Möglichkeit für die Serien HD, unzähligen graphischen Darstellungen in höher Auflösung zu realisieren. Kann Optik mit enormen chromatischen Varianten und mehrseitigen Seiten entwickeln.



**TUSCANIA**  
gres porcellanato

## signs of style

I colori e gli effetti riportati sul presente catalogo sono indicativi per i limiti consentiti dalla stampa; per questo non possono essere vincolanti e costituire base per eventuali contestazioni.

Colours and aesthetic results of this catalogue are indicative due to the printing process limits. Possible variations may occur and can not be the base for any claims.

Les couleurs et les effets présentés dans ce catalogue sont indicatifs dans la mesure permise par la presse, ce qui explique pourquoi ils ne peuvent pas être obligatoires et constituer la base d'un éventuel désaccord.

Die in diesem Katalog gezeigten Farben und Effekte sind Richtwerte, soweit durch die Presse, die ist, warum sie nicht bindend und stellen die Grundlage für eine Meinungsverschiedenheit gestattet.

Marketing:  
Manifattura Cotto Tuscania

Credit:  
**EUREKAI**

stampa:  
Lito Group srl

finito di stampare:  
Settembre 2015







Manifattura Cotto Tuscania S.p.A.  
Via Giardini Sud, 4603  
41028 Serramazzoni (Mo) - Italia  
Tel. +39 0536.952399  
Fax +39 0536.954716  
[info@cottotuscania.it](mailto:info@cottotuscania.it)  
[www.cottotuscania.it](http://www.cottotuscania.it)