

**Oz  
Glass  
Box  
Zenith**

**GSSG**  
CERAMIC DESIGN



[www.ceramicagsg.it](http://www.ceramicagsg.it)

## L'azienda *Company Profile*

GSG Ceramic Design considera elementi base del suo percorso creare ceramiche che possano, con la loro forte personalità, creare/evocare stimolanti suggestioni.

La continua ricerca estetico-tecnica ha portato questa piccola azienda ad essere conosciuta internazionalmente con una ben precisa immagine. Questo risultato è dovuto sia al talento artistico di Massimiliano Abati per la sua innovativa proposta formale sia alla professionalità dell'Azienda maestra nell'innovare costantemente nel solco di una grande tradizione tecnica. Gli oggetti prodotti sono esclusivi e carichi di significati intellettuali. Il loro utilizzo conduce a scenari estetici inesplorati.

Piccole ma grandi opere aperte.

*GSG Ceramic Design considers basic elements of his personal path to create ceramics that they can with their strong personalities create / evoke stimulating suggestions.*

*The continuous aesthetic and technical research has led this small company to be known internationally with a very specific image.*

*This result is due both to the artistic talent of Massimiliano Abati for his innovative formal proposal and to the company's professionalism with his constantly innovating in the wake of a great technical tradition.*

*The produced items are exclusive and plenty of intellectual meanings.*

*Their choice leads any user to aesthetic scenarios still unexplored. Small but big open works.*

**GSGi**  
CERAMIC DESIGN

# Processo produttivo Manufacturing process

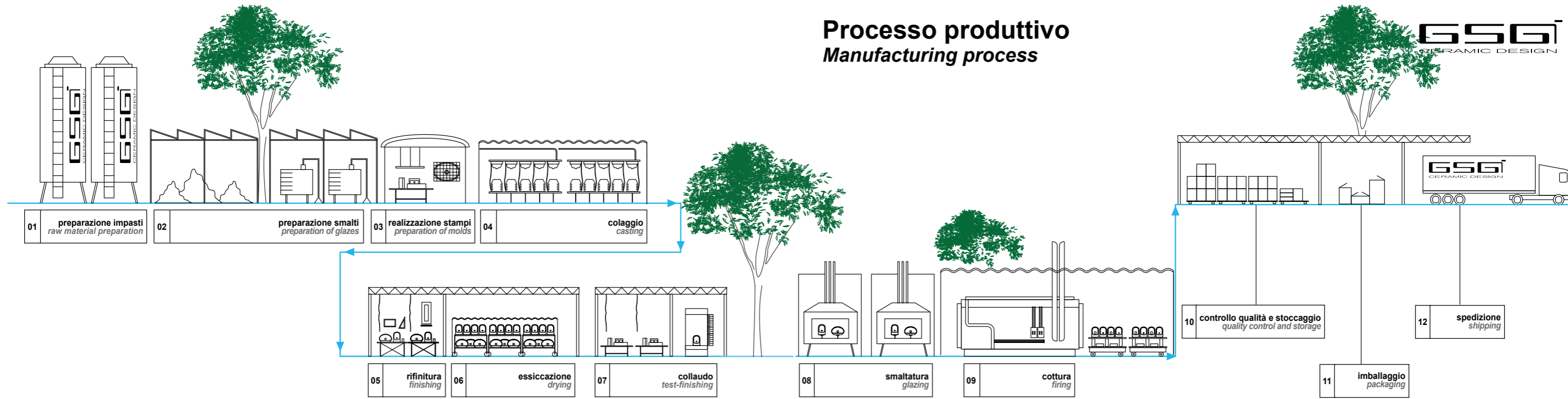

01	02	03	04	05	06	07	08	09	10	11	12
preparazione impasti raw material preparation	preparazione smalti preparation of glazes	realizzazione stampi preparation of molds	colaggio casting	rifinitura finishing	essiccazione drying	collaudo test-finishing	smaltatura glazing	cottura firing	controllo qualità e stoccaggio quality control and storage	imballaggio packaging	spedizione shipping

L'utilizzo di materie prime di primaria qualità, permettono di ottenere gli impasti comunemente usati per la ceramica sanitaria: Vetro China, ottenuta con l'utilizzo di alte percentuali di caolino e quarzo, che la rendono più pura e fine, e Fire Clay, ottenuto utilizzando meno caolino e più materiali inerti.

L'alta qualità degli smalti adoperati è garantita dai continui tests a cui vengono sottoposti, per esprimere al meglio la corretta sintonia con il supporto ceramico, l'adeguata corrispondenza della tonalità di colore e le caratteristiche di resistenza che le normative impongono.

GSG Ceramic Design utilizza solo gesso di altissima qualità per la realizzazione dei suoi stampi. Il gesso permette, mediante il principio di assorbimento d'acqua, di creare le condizioni affinché il prodotto, nella sua prima fase di lavorazione, possa essere facilmente isolato.

Gli impasti precedentemente preparati, Vetro China o Fire Clay, vengono iniettati, manualmente o con l'ausilio di appositi macchinari, all'interno degli stampi in gesso mediante i quali, per mezzo del principio di assorbimento d'acqua, si ottiene il prodotto preformato avente il giusto spessore della materia.

La prima fase di rifinitura è a cura di mastri esperti che, manualmente, rimuovono ogni imperfezione dovuta ad esempio ad impasto eccedente nelle giunture tra i pezzi dello stampo o ad altre cause nel processo di modellazione. Eventuali articoli non idonei agli alti standard GSG saranno rimossi dalla produzione e riutilizzati come materiale da reimasto.

Per ridurre in modo importante il processo di asciugatura dei prodotti senza tuttavia comprometterne l'integrità cioè senza provocare fessurazioni, essi vengono trasportati in un essiccatoio automatico dove viene forzata in modo controllato una rapida e significativa perdita d'acqua e quindi di peso.

I prodotti vengono sottoposti ad una ulteriore fase di rifinitura, sempre manuale, ancora più attenta e approfondita, al fine di ottenere prodotti privi di imperfezioni.

La smaltatura, effettuata manualmente da mastri smaltatori, è applicata a tutte le superfici esterne ed interne di ogni articolo, evitando accuratamente che in ogni prodotto rimangano parti non smaltate.

I prodotti smaltati attentamente caricati sulle strutture vengono inviati al forno per la cottura. In GSG il ciclo di cottura ha una durata di ca. 22 ore e segue un preciso programma di fasi tutte determinanti per l'ottenimento di un risultato finale ottimale. I prodotti sono pre-riscaldati, quindi portati lentamente alla temperatura di cottura che in GSG è 1250° C., quindi passano alla fase di "permanenza" ed infine al raffreddamento.

I prodotti selezionati e corrispondenti agli standard GSG vengono stoccati nel nostro magazzino. I prodotti sono suddivisi per serie, tipologia e colore o decorazione. Tutto il magazzino è controllato on time dal nostro sistema di gestione per poter rispondere tempestivamente e correttamente alle richieste della clientela.

Ogni articolo viene singolarmente scatolettato, posto sul pallet e avvolto da una pellicola protettiva in PVC termoretraibile.

I nostri prodotti sono tutti pallettizzati per la loro sicurezza e facilità di trasporto. GSG è in grado di caricare pallettizzati su qualsiasi mezzo di trasporto su gomma con pianale e di predisporre containers sia di 20' che 40'.

The use of finest quality raw materials, permits us to use fewer inert materials: Vitreous China is made with high percentages of kaolin and quartz, making it purer and finer. Fire Clay, is obtained using less kaolin and more inert materials.

The high quality of glazes used is always being tested continually giving a correct harmony for the ceramic production, a guarantee of colour tones and resistance that international standards require.

GSG Ceramic Design uses only the highest quality plaster for the construction of its molds. Plaster allows, by means of the principle of water absorption, to create the conditions so that the product, in its first stage of processing, it can be easily isolated.

Vitreous China or Fire Clay previously prepared, are injected, manually or with the aid of suitable machinery, to the interior of plaster molds, by means of the principle of water absorption, the product is obtained prefinished and having the right thickness of the material.

The first stage of finishing is curated by expert masters that, manually, remove all imperfections due for example to excess dough in the joints between the pieces of the mold or other causes in the modeling process. Any items not suitable to the GSG high standards will be removed from production and reused as material for re-mix.

To drastically reduce the drying process of the products without compromising their integrity that is, without causing cracks, they are transported in an automatic dryer where it is forced in a controlled manner a rapid and significant loss of water and therefore weight.

Any item it's subjected to a further step of finishing, always manual, even more careful and thorough, in order to obtain products free of imperfections.

Glazing, hand made by master glazers, is applied to all external and internal surfaces of each item, carefully avoiding that in every product remain unglazed parts.

The glazed products carefully loaded on the wagons are sent to the kiln for firing. In GSG the firing cycle has a duration of about 22 hours, following a precise schedule of all phases determinants for obtaining an optimum end result. The products are pre-heated, then slowly brought to the firing temperature which GSG is 1250 ° C., then pass to the phase of "permanence" and finally to the cooling.

Products selected and meeting the GSG standards are stored in our warehouse. The products are subdivided in series, type and color or decoration. All warehouse it's controlled on time by our management system in order to respond promptly and correctly to our customers' requests.

Each item is separately packed in a single cardboard box, placed on pallets and wrapped in protective PVC shrink film.

Our products are all palletized for their safety and ease of transport. GSG is able to load pallets on any means of transport on the platform with rubber and to prepare both containers 20' to 40'.

# Stabilimento



# Factory

Plus tecnologici per le collezioni OZ, GLASS e BOX  
*Technological Plus for OZ, GLASS and BOX collections*

**Plus wc OZ, GLASS & BOX**



wc bidet



saving water

Plus tecnologici per le collezioni OZ, GLASS e BOX  
*Technological Plus for OZ, GLASS and BOX collections*

**Plus coprivaso - seat cover  
 OZ, GLASS & BOX**



plexiglass



termoindurente  
 thermoindurent



avvolgente  
 wrapover

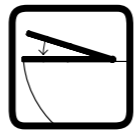

soft close

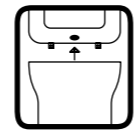

sgancio rapido  
 quick release

Caratteristiche lavabi  
*Washbasins features*

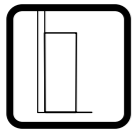

parete  
 back to wall

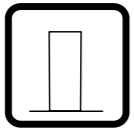

centro stanza  
 free standing

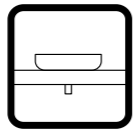

appoggio  
 countertop

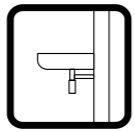

sospeso  
 wall-hung

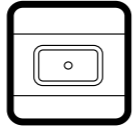

free standing

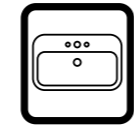

monoforo - tre fori  
 one hole - three holes

⑥ \_\_\_\_\_ **Collezioni / Collections Oz**

④⑧ \_\_\_\_\_ **Schede tecniche Oz**  
*Technical measurements Oz  
 and washbasins*

⑤⑥ \_\_\_\_\_ **Collezioni / Collections Glass**

⑦② \_\_\_\_\_ **Schede tecniche Glass**  
*Technical measurements Glass  
 and washbasins*

⑦⑥ \_\_\_\_\_ **Collezioni / Collections Box**

⑨① \_\_\_\_\_ **Schede tecniche Box**  
*Technical measurements Box  
 and washbasins*



# Collezione **Oz**

## Concept Oz

Oz è un concetto, è l'assimilazione e al tempo stesso l'indifferenza verso i canoni e i codici. "SCAVARE", è l'azione che ha mosso lo spirito formale: segni impressi nella materia che costituiscono le radici del tempo e della tradizione. L'intenzione formale era quella di racchiudere questi concetti in un oggetto; decostruire il pensiero e la forma plastica, in un risultato di assoluto equilibrio. I "graffi" impressi nella materia sono gesti di rottura e di una certa violenza, ma anche benevoli, perchè si ricompattano per uno scopo specifico: quello di accogliere l'acqua e farla defluire nuovamente nella materia. L'invito a chi sceglie questo concept set è quello di parlarne come si argomenta su un'opera d'arte, perchè oltre ad assolvere le sue funzioni precise, è avanguardia.

*Oz is a concept, it is assimilation and at the same time indifference towards standards and codes. "Digging" is the action that has thrust forward the formal spirit: marks impressed onto matter that make up the roots of time and tradition. The "scratches" left on matter are violent as well as benign breaking gestures all serving a specific purpose: receiving water and making it flow back into matter. Those who choose this concept set are invited to discuss it as one usually does with a work of art, since it serves its specific functions in an avant-guard way.*

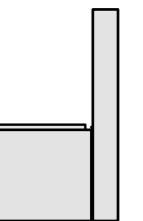
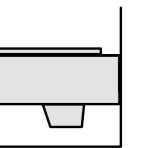



# OZ

Versione a terra *Back to wall*

# Oz

**Minimalismo ed Eleganza**  
Minimalism and Elegance



Wc Oz a terra  
Wc Oz back to wall  
Cod. OZWC01

Bidet Oz a terra  
Bidet Oz back to wall  
Cod. OZBI01







Oz

# Oz

Versione sospesa Wall-hung



# Oz



# Oz

**Minimalismo ed Eleganza**  
Minimalism and Elegance



Wc Oz sospeso  
Wc Oz wall-hung  
Cod. OZWCSO

Bidet Oz sospeso  
Bidet Oz wall-hung  
Cod. OZBISO

# Oz



# Oz

**Minimalismo ed Eleganza**  
Minimalism and Elegance



Cassetta a colonna Oz  
Oz column cistern  
Cod. OZCIMBL

Wc Oz a terra  
Wc Oz back to wall  
Cod. OZWC01

Bidet Oz a terra  
Bidet Oz back to wall  
Cod. OZBI01





# Oz

Collezione lavabi  
Washbasins collection



Lavabo Oz 95 Dx  
Right Oz washbasin 95  
Cod. LAOZ

# Oz

Collezione lavabi  
Washbasins collection



Cod. LAOZ Oz 95x47



Cod. LAOZ65 Oz 65x47

**GSG**  
CERAMIC DESIGN



# Oz

Oz





# Oz



# Oz

**Minimalismo ed Eleganza**  
Minimalism and Elegance



Lavabo Oz 65  
Oz washbasin 65  
Cod. LAOZ65

# Venus

Vasca in acrilico  
Acrylic Bathtub



Vasca Venus  
Venus Bathtub  
Cod. VAVE

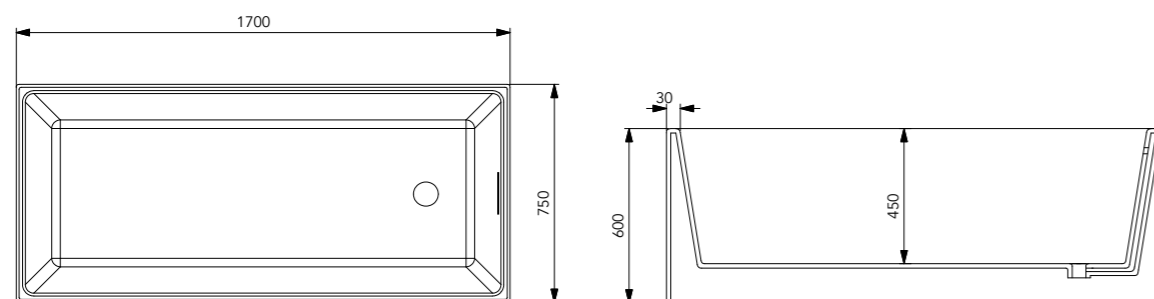

# Oz

Vasca in Pietraluce  
Pietraluce Bathtub



Vasca Oz  
Oz Bathtub  
Cod. OZVA180

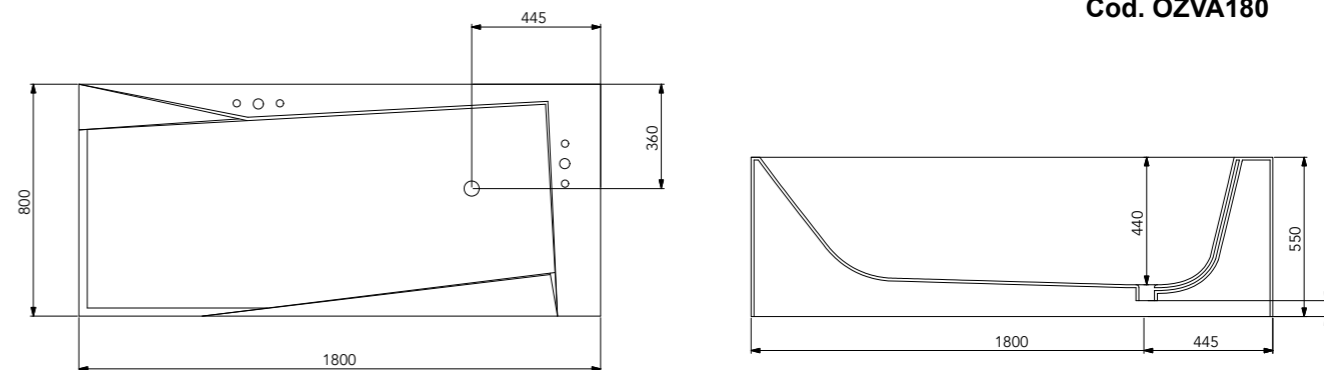

# Quad

Collezione lavabi  
Washbasins collection



Lavabo Quad 60  
Quad washbasin 60  
Cod. QULAV60



Quad 60x47  
Cod. QULAV60



Quad 80x47  
Cod. QULAV80



# Quad

# Square



## Square

**Collezione lavabi**  
Washbasins collection



Lavabo Square 32  
Square washbasin 32  
**Cod. SQUALAV**



Square 32x37  
**Cod. SQUALAV**

# Zenith

Collezione lavabi  
Washbasins collection



Lavabo Zenith cm 102  
Zenith washbasin cm 102  
Cod. ZELAVBW102



# Zenith



# Zenith

## Zenith

Collezione lavabi  
Washbasins collection



Lavabo Zenith cm 80  
Zenith washbasin cm 80  
Cod. ZELAVBW80



Zenith BW 102x46  
Cod. ZELAVBW102



Zenith BW 80x46  
Cod. ZELAVBW80



Zenith BW 60x46  
Cod. ZELAVBW60



Zenith BW 50x46  
Cod. ZELAVBW50

# Zenith

Collezione lavabi  
Washbasins collection



Lavabo Zenith cm 80  
Zenith washbasin cm 80  
Cod. ZELAVFS80



Zenith FS 100x40  
Cod. ZELAVFS100



Zenith FS 80x40  
Cod. ZELAVFS80



Zenith FS 60x40  
Cod. ZELAVFS60



Zenith FS 50x40  
Cod. ZELAVFS50



# Zenith

# Zenith BW

Lavabo Zenith bordo fino, cm 102  
Zenith wahbasin cm 102 thin edge  
**COD ZELAVBW102**



# Zenith FS

Lavabo Zenith bordo fino, cm 100  
Zenith wahbasin cm 100 thin edge  
**COD ZELAVFS100**



Lavabo Zenith bordo fino, cm 80  
Zenith wahbasin cm 80 thin edge  
**COD ZELAVBW80**



Lavabo Zenith bordo fino, cm 80  
Zenith wahbasin cm 80 thin edge  
**COD ZELAVFS80**



Lavabo Zenith bordo fino, cm 60  
Zenith wahbasin cm 60 thin edge  
**COD ZELAVBW60**



Lavabo Zenith bordo fino, cm 60  
Zenith wahbasin cm 60 thin edge  
**COD ZELAVFS60**



Lavabo Zenith bordo fino, cm 50  
Zenith wahbasin cm 50 thin edge  
**COD ZELAVBW50**



Lavabo Zenith bordo fino, cm 50  
Zenith wahbasin cm 50 thin edge  
**COD ZELAVFS50**





# Oz

**Minimalismo ed Eleganza**  
Minimalism and Elegance



Bidet Oz a terra  
Bidet Oz back to wall  
Cod. OZBI01

Wc Oz a terra  
Wc Oz back to wall  
Cod. OZWC01



## Ingombri Measure



COD OZWC01

COD OZBI01



COD OZWC50

COD OZBISO



COD OZCIMBL

COD OZWC01

COD OZBI01



Wc Oz a terra Wc Oz back to wall  
Bidet Oz a terra Bidet Oz back to wall

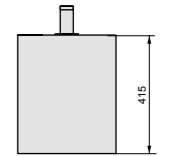
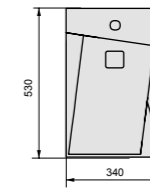
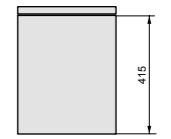
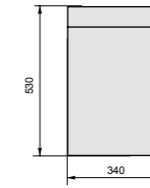

Wc Oz sospeso Wc Oz wall-hung  
Bidet Oz sospeso Bidet Oz wall-hung

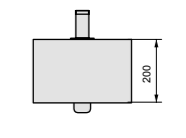
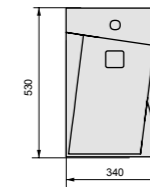
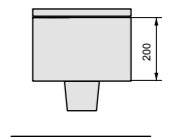
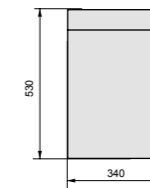

Wc Oz a terra con cassetta Wc Oz back to wall with cistern  
Bidet Oz a terra Bidet Oz back to wall

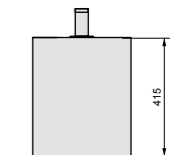
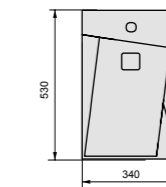
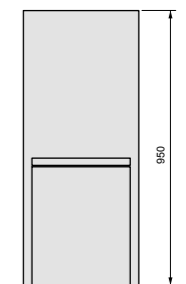
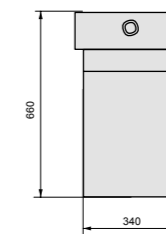

## Lavabi per collezione Oz Washbasins suitable for Oz collection



Square



Quad



Zenith bw



Zenith fs



Box



Cod. SQULAV  
32x37xh13



Cod. QULAV60  
60x47xh13



Cod. ZELAVBW50  
50x46x14



Cod. ZELAVFS50  
50x40xh14

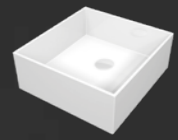

Cod. BXLA33  
33x35xh13

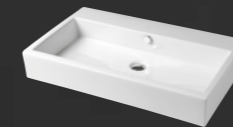

Cod. QUALV80  
80x47xh13



Cod. ZELAVBW60  
60x46xh14



Cod. ZELAVFS60  
60x40xh14



Cod. BXLA31  
31,5x31,5xh24,5



Cod. ZELAVBW80  
80x46xh14



Cod. ZELAVFS80  
80x40xh14

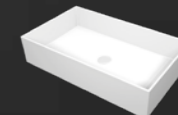

Cod. BXLA60  
60x35,5xh13



Cod. ZELAVBW102  
102x46xh14



Cod. ZELAVFS100  
100x40xh14

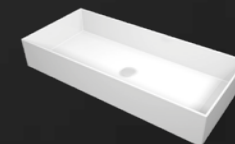

Cod. BXLA80  
80x35,5xh13



## Lavabi Washbasins

In abbinamento alla collezione Oz, proponiamo 15 lavabi dalle diverse misure e caratteristiche tecnologiche.  
For Oz collection we propose 15 different washbasins in sizes and technological characteristics.

cod. OZWC01  
Vaso Oz scarico parete convertibile a pavimento mediante curva tecnica  
*Wc Oz wall drain suitable for floor drain with technical elbow*

cod. OZWC01

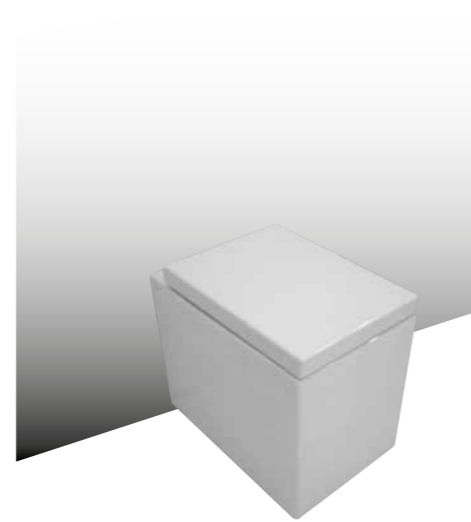
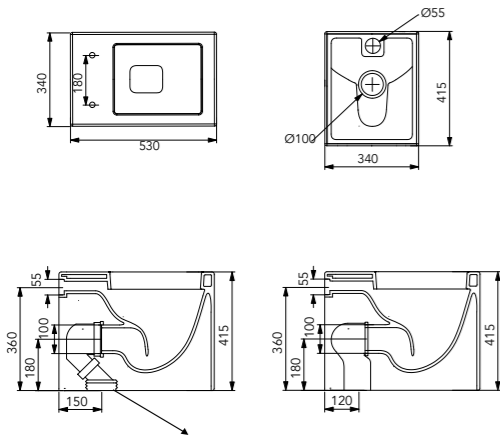

Con connessione eccentrica per scarico a suolo  
*With outlying damage connector for floor trap*

cod. OZBI01  
Bidet Oz monoforo (senza foro e tre fori su richiesta)  
*Bidet Oz one hole (without hole and three holes on request)*

cod. OZBI01

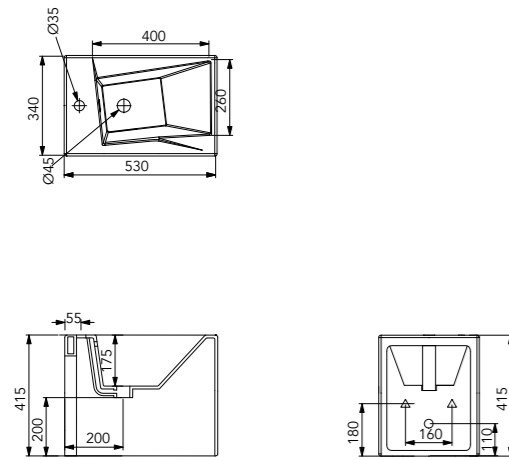

cod. OZWC01  
Vaso Oz scarico parete convertibile a pavimento mediante curva tecnica  
*Wc Oz wall drain suitable for floor drain with technical elbow*

cod. OZCIMBL  
Cassetta a colonna Oz  
*Column cistern Oz*

cod. OZCIMBL  
cod. OZWC01

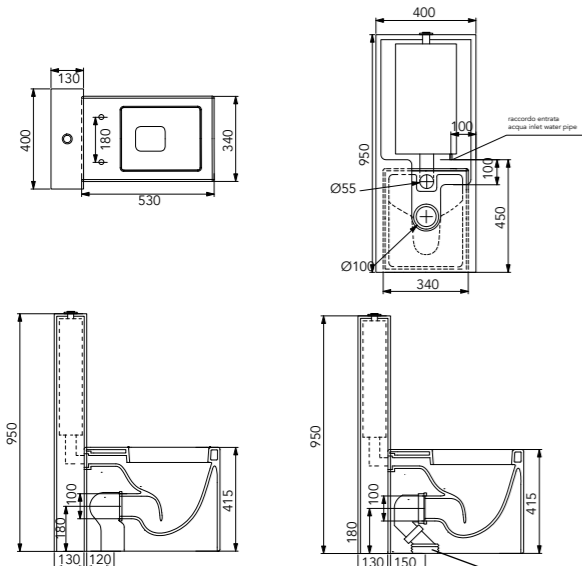

Con connessione eccentrica per scarico a suolo  
*With outlying damage connector for floor trap*

cod. OZWC01  
Vaso Oz scarico parete convertibile a pavimento mediante curva tecnica  
*Wc Oz wall drain suitable for floor drain with technical elbow*

cod. OZWC01

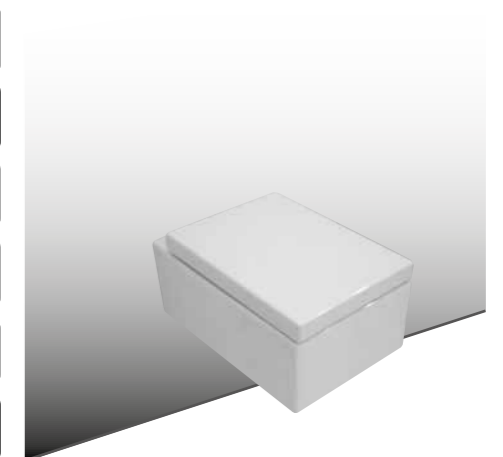
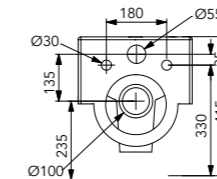
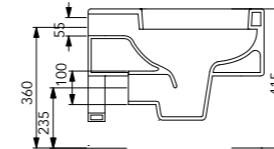
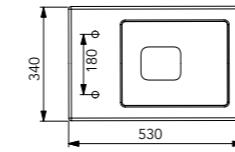

cod. OZBISO  
Bidet Oz sospeso monoforo (senza foro su richiesta)  
*Bidet Oz wall-hung one hole (without hole on request)*

cod. OZBISO

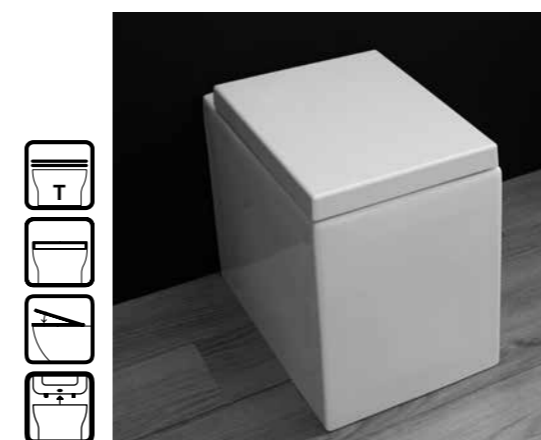
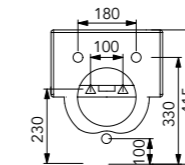
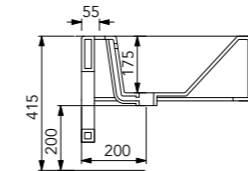
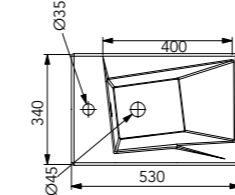

Coprivaso in termoindurente Avvolgente con Sgancio rapido  
*Thermosetting Wrapover Seat Cover with Quick Release*  
OZCOPRTISR

Coprivaso in termoindurente Avvolgente Chiusura Rallentata e Sgancio rapido  
*Thermosetting Wrapover Seat Cover Soft Close and Quick Release*

OZCOPRTICRSR



Coprivaso in termoindurente Avvolgente con disegno OZ  
*Thermosetting Wrapover Seat Cover with Oz design*  
OZCOPRTI

Coprivaso in termoindurente Avvolgente Chiusura Rallentata e disegno Oz  
*Thermosetting Wrapover Seat Cover, Soft Close with Oz design*

OZCOPRTICR

cod. LAOZ65  
Lavabo Oz cm65  
Oz washbasin cm65

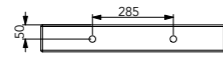
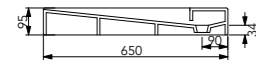
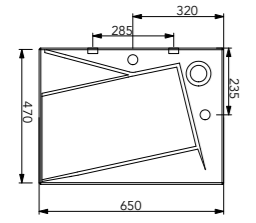

cod. LAOZ65

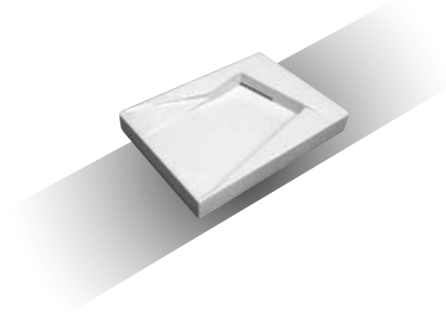

cod. LAOZ  
Lavabo Oz cm95 versione destra  
Oz washbasin cm95 right version

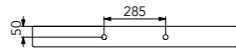
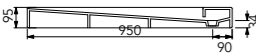
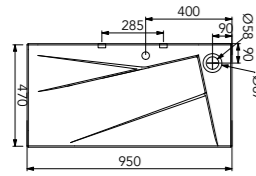

cod. LAOZ

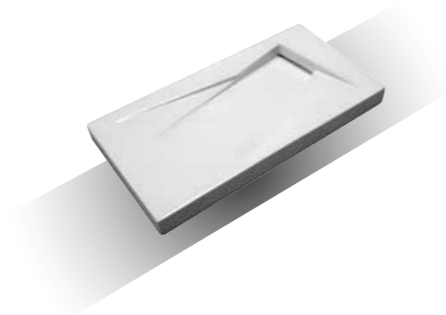

cod. SQULAV  
Lavabo Square cm32  
Square washbasin cm32

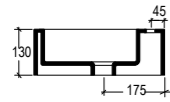
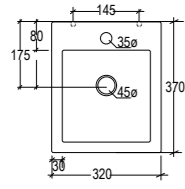

cod. SQULAV

cod. ZELAVFS80  
Lavabo Zenith bordo fino cm80  
Zenith washbasin cm80 thin edge

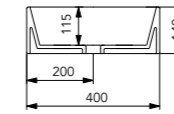
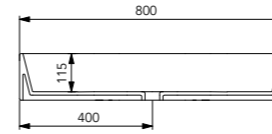
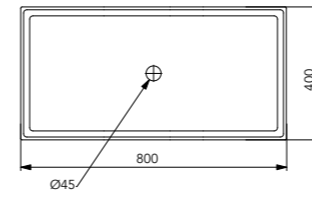

cod. ZELAVFS80

cod. ZELAVFS50  
Lavabo Zenith bordo fino cm50  
Zenith washbasin cm50 thin edge

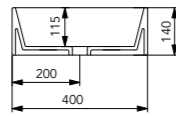
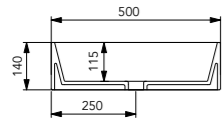
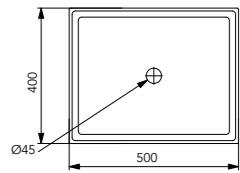

cod. ZELAVFS50

cod. ZELAVFS100  
Lavabo Zenith bordo fino cm100  
Zenith washbasin cm100 thin edge

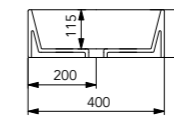
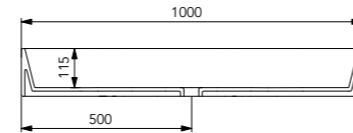
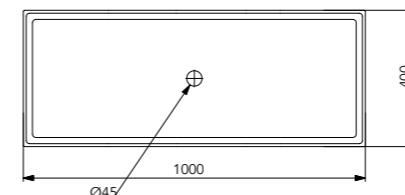

cod. ZELAVFS100

cod. ZELAVFS60  
Lavabo Zenith bordo fino cm60  
Zenith washbasin cm60 thin edge

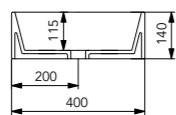
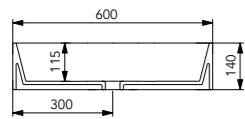
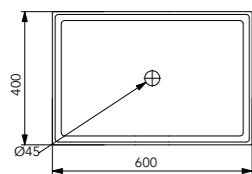

cod. ZELAVFS60

cod. QULAV60  
Lavabo Quad cm60  
Quad washbasin cm60

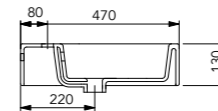
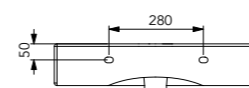
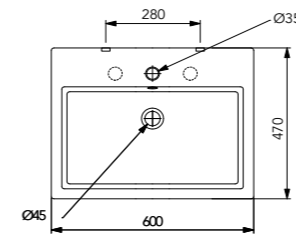

cod. QULAV60

cod. QULAV80  
Lavabo Quad cm80  
Quad washbasin cm80

cod. QULAV80

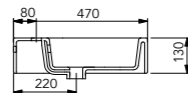
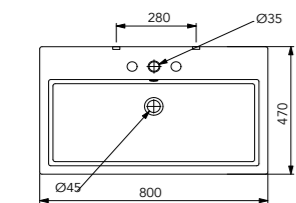

cod. ZELAVBW80  
Lavabo Zenith bordo fino cm80  
Zenith washbasin cm80 thin edge

cod. ZELAVBW80

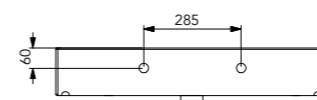
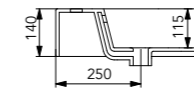
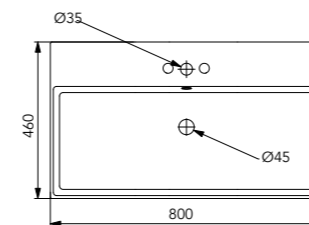

cod. ZELAVBW50  
Lavabo Zenith bordo fino cm50  
Zenith washbasin cm50 thin edge

cod. ZELAVBW50

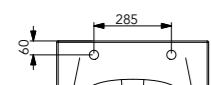
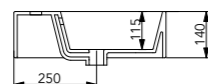
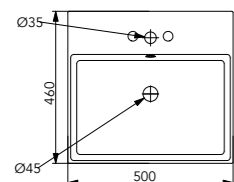

cod. ZELAVBW102  
Lavabo Zenith bordo fino cm102  
Zenith washbasin cm102 thin edge

cod. ZELAVBW102

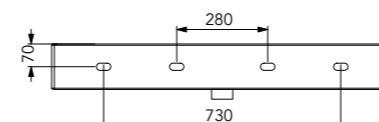
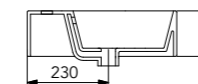
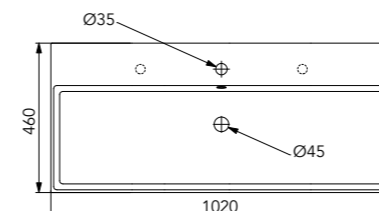

cod. ZELAVBW60  
Lavabo Zenith bordo fino cm60  
Zenith washbasin cm60 thin edge

cod. ZELAVBW60

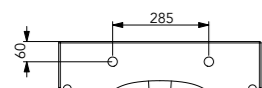
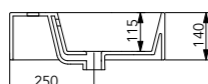
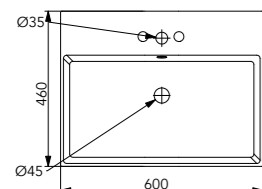

LE MISURE INDICATE POSSONO VARIARE DEL 2% CIRCA, PER USURA STAMPI E PER VARIAZIONI DELLE CARATTERISTICHE TECNICHE DELLE MATERIE PRIME.

THE INDICATED SIZE COULD HAVE A VARIATION OF ABOUT 2% DUE TO THE USURE OF MOULDS AND VARIATIONS IN THE RAW MATERIALS.

# Collezione Glass

## Concept Glass

Leggerezza, innovazione, modularità, pulizia, sono prerogative chiaramente manifeste in questo concept. All'estrema pulizia formale del vetro, relegato ad involucro per l'acqua, si accosta la ceramica, risolta in forme pure che sostengono gli elementi in cristallo. È un concept fortemente architettonico: vuoti e sovrapposizioni di trasparenze unite agli elementi portanti in ceramica, sembrano costituire dei "loft" in scala ridotta. Il tutto restituisce a chi la vive suggestioni impalpabili ed eteree. Il cristallo, evoca ed enfatizza i riflessi evanescenti e sempre indefiniti dell'acqua; la ceramica ha il ruolo di sostenerne la gravità ponendo dei limiti percettivi.

*Lightness innovation consistency, cleanliness, are prerogatives contained within the new concept of the GSG ceramic Design. The extreme formal linearity of glass, creates a shell for water connecting the ceramic forms which support the elements in cristal. It is a strong architectural concept: emptiness and transparent overlappings conjointly with supporting ceramic elements, giving one the sensation of intangibility. Cristal evokes faint, reflections, always indefinite; ceramic supports the power of gravity creating detectable limits.*

# Glass

Collezione lavabi  
Washbasins collection



Lavabo Glass 60 in vetro su mensole in ceramica  
Glass washbasin 60 in glass on ceramic shelves  
Cod. GLLAME60



Glass 60x49  
Cod. GLLAME60



Glass 80x49  
Cod. GLLAME80



Glass 120x49  
Cod. GLLAME120

# Glass





# Glass



## Glass

Collezione lavabi  
Washbasins collection



Lavabo Glass 80 a colonna centro stanza con bacino in vetro  
*Column Glass washbasin 80 free standing with glass float*  
Cod. GLLACOL80FS



Glass 60x49x88,5  
Cod. GLLACOL60FS



Glass 80x49x88,5  
Cod. GLLACOL80FS



Glass 120x49x88,5  
Cod. GLLACOL120FS

# Glass

Innovazione e Trasparenza  
Innovation and Transparency



Lavabo Glass 80 a colonna a parete con bacino in vetro  
*Column Glass washbasin 80 back to wall with glass float*  
Cod. GLLACOL80BW



Glass 60x49x88,5  
Cod. GLLACOL60BW



Glass 80x49x88,5  
Cod. GLLACOL80BW



Glass 120x49x88,5  
Cod. GLLACOL120BW



# Glass



# Glass

Innovazione e Trasparenza  
Innovation and Transparency



Lavabo in vetro cm 33  
Glass washbasin cm 33  
Cod. GLFLOATBI

# Glass



# Glass



# Glass

**Innovazione e Trasparenza**  
Innovation and Transparency



Lavabo in vetro cm 31,5  
Glass washbasin cm 31,5  
Cod. GLLA31



# Glass

**Innovazione e Trasparenza**  
Innovation and Transparency



Lavabo in vetro cm 120  
Glass washbasin cm 120  
Cod. GLLA120

**cod. GLLA60**  
Lavabo Glass in vetro cm60  
Glass washbasin in glass cm60

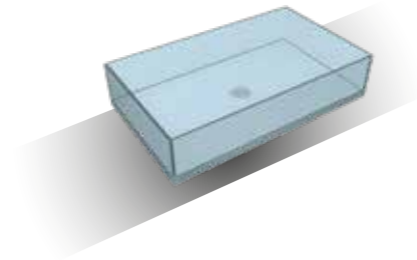
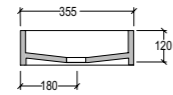
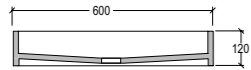
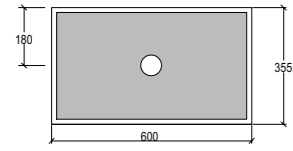

**cod. GLLA60**

**cod. GLLA31**  
Lavabo Glass in vetro cm31,5  
Glass washbasin in glass cm31,5

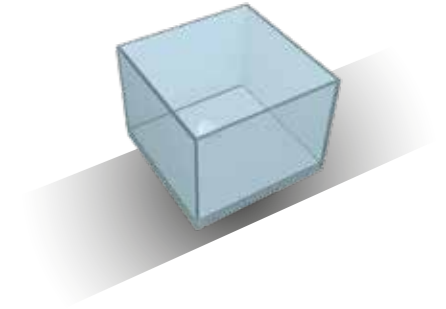
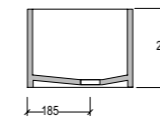
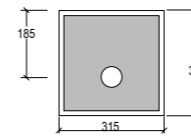

**cod. GLLA31**

**cod. GLLA80**  
Lavabo Glass in vetro cm80  
Glass washbasin in glass cm80

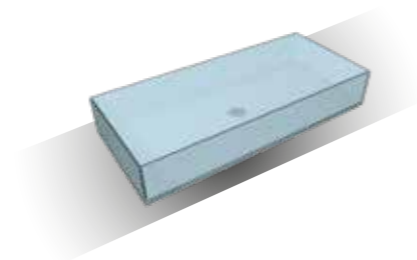
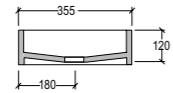
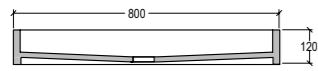
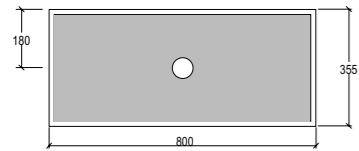

**cod. GLLA80**

**cod. GLLA33**  
Lavabo Glass in vetro cm33  
Glass washbasin in glass cm33

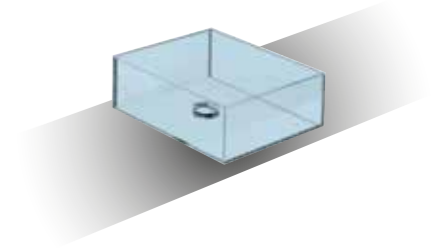
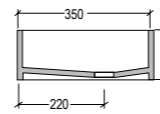
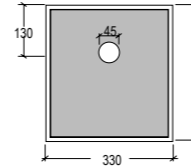

**cod. GLLA33**

**cod. GLLA120**  
Lavabo Glass in vetro cm120  
Glass washbasin in glass cm120

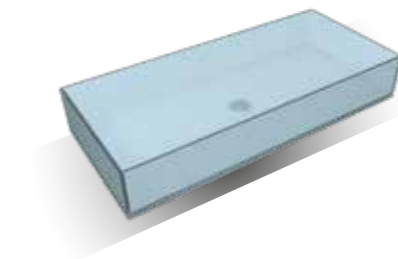
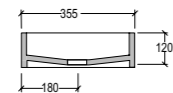
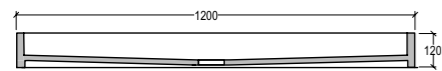
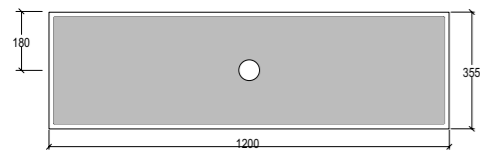

**cod. GLLA120**

**cod. GLSCBW**  
Supporto singolo destro o sinistro in ceramica  
per lavabo a colonna a parete.  
*Single ceramic support left or right for column  
Washbasin back to wall.*

**cod. GLSCFS**  
Supporto singolo destro o sinistro in ceramica  
per lavabo a colonna centro stanza.  
*Single ceramic support left or right for column  
Washbasin free standing.*

**cod. GLSCFS/GLSCBW**

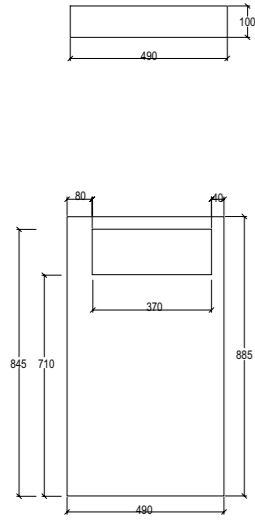

**cod. GLME**  
Mensola di supporto singola in ceramica  
per lavabi da appoggio o sospesi Glass  
*Single ceramic shelf for countertop or wall  
hung Washbasin Glass*

**cod. GLME**

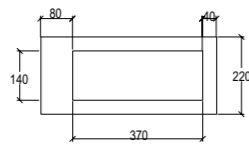
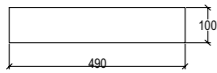

LE MISURE INDICATE POSSONO VARIARE DEL 2% CIRCA, PER USURA STAMPI E PER VARIAZIONI DELLE CARATTERISTICHE TECNICHE DELLE MATERIE PRIME.

THE INDICATED SIZE COULD HAVE A VARIATION OF ABOUT 2% DUE TO THE USURE OF MOULDS AND VARIATIONS IN THE RAW MATERIALS.



# Collezione **Box**

## Concept Box

Lo spigolo sottile la conseguenza naturale delle ridotte sezioni. Superfici minime, tecnica costruttiva a servizio della forma, per spazi architettonici contemporanei. Esperimento con combinazione di materiali diversi, ceramica / crystal-tech, per soluzioni inedite e flessibili.

*The thin edge is the natural consequence of reduced sections. Minimal surfaces, constructive design for usefulness of the shaping, for contemporary architectural spaces. Experiment with combination of different materials, ceramic / crystal-tech, for unusual and flexible solutions.*

# Box



# Box



## Box

Collezione lavabi  
Washbasins collection



Bacino Box in crystal-tech cm 33  
Float Box in crystal-tech cm 33  
Cod. BXL33



Box 33x35  
Cod. BXL33



Box 31,5x31,5  
Cod. BXL31



Box 60x35,5  
Cod. BXL60



Box 80x35,5  
Cod. BXL80

# Box

Versatilità ed Originalità  
Versatility and Originality



Bacino Box in crystal-tech cm 31,5  
Float Box in crystal-tech cm 31,5  
Cod. BXLA31



# Box

# Box



# Box

**Versatilità ed Originalità**  
Versatility and Originality



Lavabo sospeso 60 su coppia di mensole  
*Wall hung washbasin 60 on shelves*  
**Cod. BXLAME60**

# Box

Versatilità ed Originalità  
Versatility and Originality



Lavabo a colonna a parete 60  
Column washbasin back to wall 60  
Cod. BXLACOL60BW

# Box



# Box

## Lavabi per collezione Box Washbasins suitable for Box collection

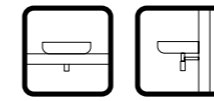

Quad

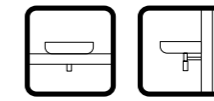

Zenith bw

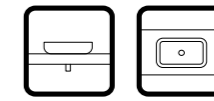

Zenith fs

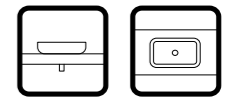

Box



Cod. QULAV60



Cod. ZELAVBW50



Cod. ZELAVFS50



Cod. BXLA33



Cod. QUALV80



Cod. ZELAVBW60



Cod. ZELAVFS60



Cod. BXLA31



Cod. ZELAVBW80



Cod. ZELAVFS80



Cod. BXLA60



Cod. ZELAVBW102



Cod. ZELAVFS100



Cod. BXLA80

## Washbasins

For Box collection we propose 14 different washbasins in sizes and technological characteristics.

**cod. BXLA60**  
Bacino in crystal-tech® cm60  
Float in crystal-tech® cm60

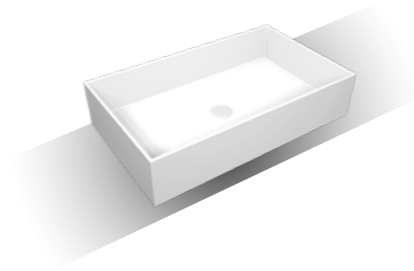
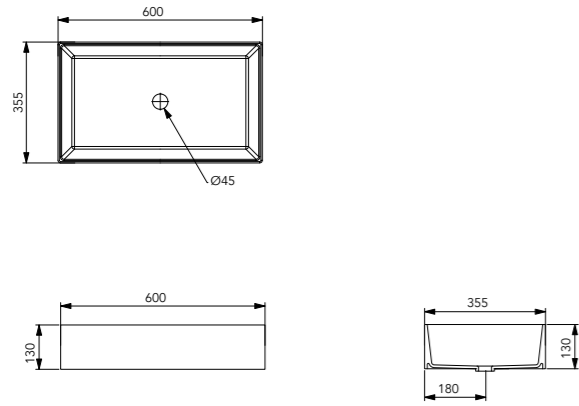

**cod. BXLA60**

**cod. BXLA33**  
Bacino in crystal-tech® cm33  
Float in crystal-tech® cm33

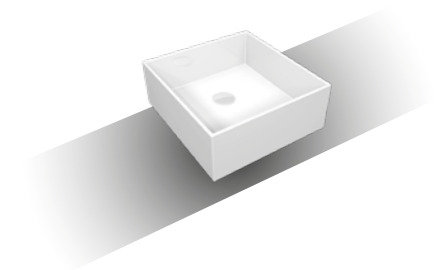
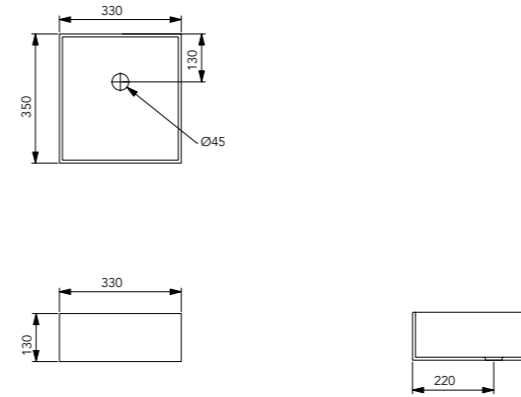

**cod. BXLA33**

**cod. BXLA80**  
Bacino in crystal-tech® cm80  
Float in crystal-tech® cm80

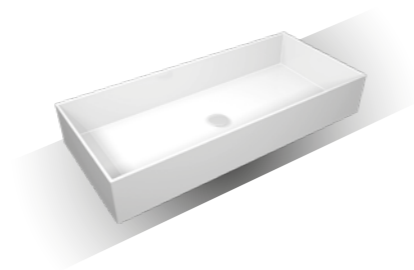
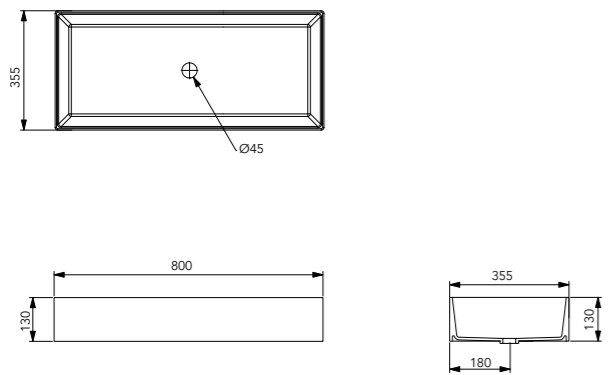

**cod. BXLA80**

**cod. ZELAVFS50**  
Lavabo Zenith bordo fino cm50  
Zenith washbasin cm50 thin edge

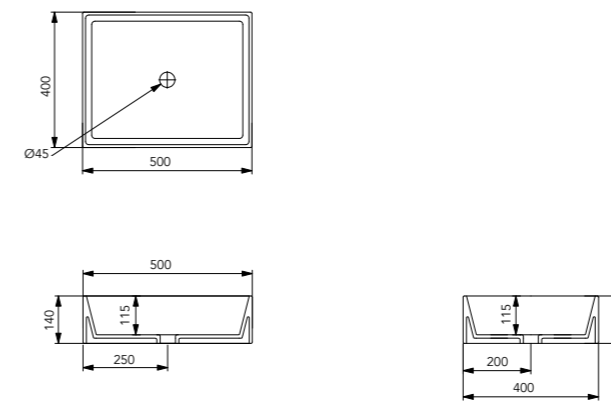

**cod. ZELAVFS50**

**cod. BXLA31**  
Bacino in crystal-tech® cm31,5  
Float in crystal-tech® cm31,5

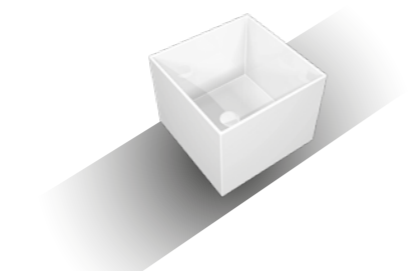
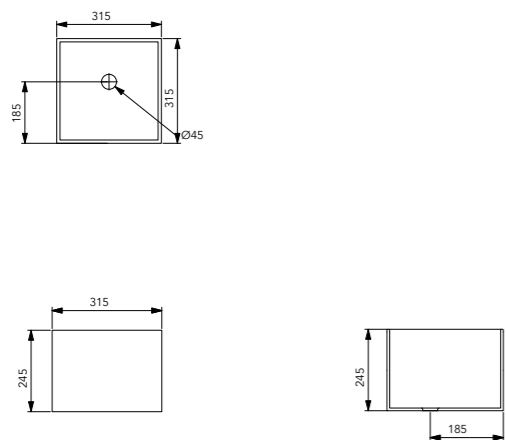

**cod. BXLA31**

**cod. ZELAVFS60**  
Lavabo Zenith bordo fino cm60  
Zenith washbasin cm60 thin edge

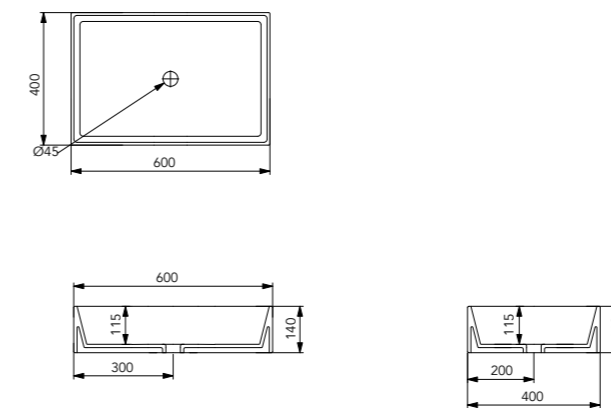

**cod. ZELAVFS60**



cod. ZELAVFS80  
Lavabo Zenith bordo fino cm80  
Zenith washbasin cm80 thin edge

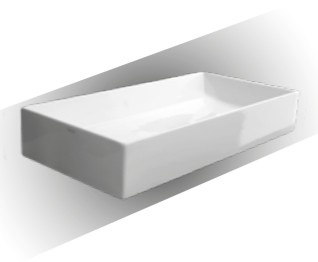
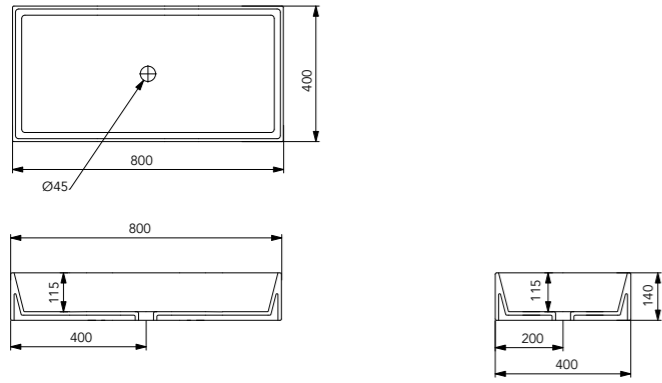

cod. ZELAVFS80

cod. ZELAVBW50  
Lavabo Zenith bordo fino cm50  
Zenith washbasin cm50 thin edge

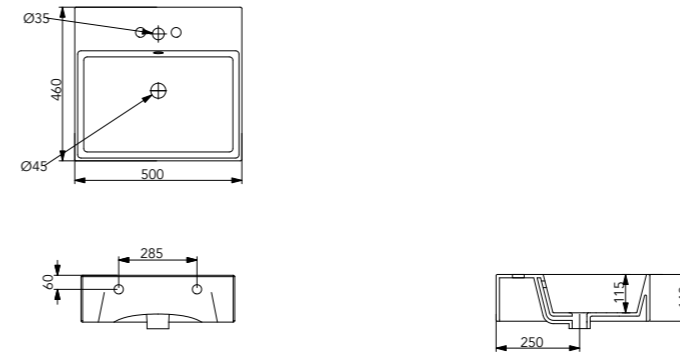

cod. ZELAVBW50

cod. ZELAVFS100  
Lavabo Zenith bordo fino cm100  
Zenith washbasin cm100 thin edge

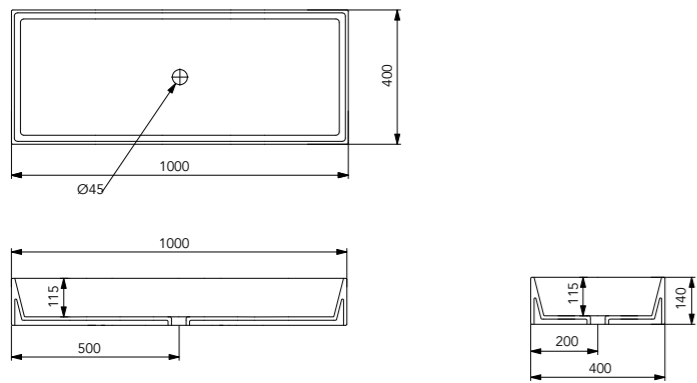

cod. ZELAVFS100

cod. ZELAVBW60  
Lavabo Zenith bordo fino cm60  
Zenith washbasin cm60 thin edge

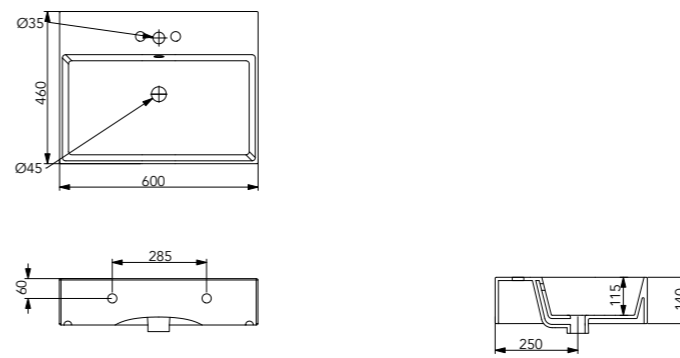

cod. ZELAVBW60

cod. QULAV60  
Lavabo Quad cm60  
Quad washbasin cm60

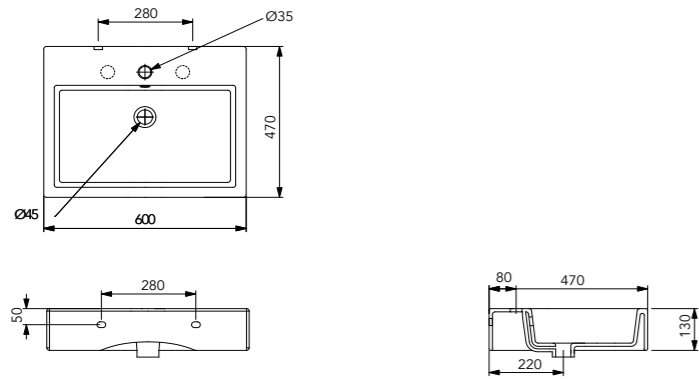

cod. QULAV60

cod. ZELAVBW80  
Lavabo Zenith bordo fino cm80  
Zenith washbasin cm80 thin edge

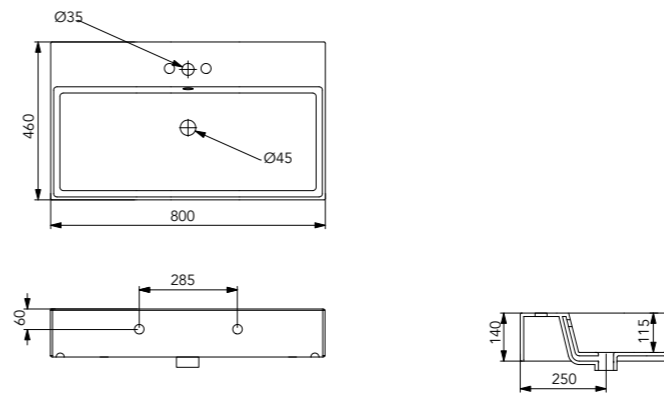

cod. ZELAVBW80

cod. QULAV80  
Lavabo Quad cm80  
Quad washbasin cm80

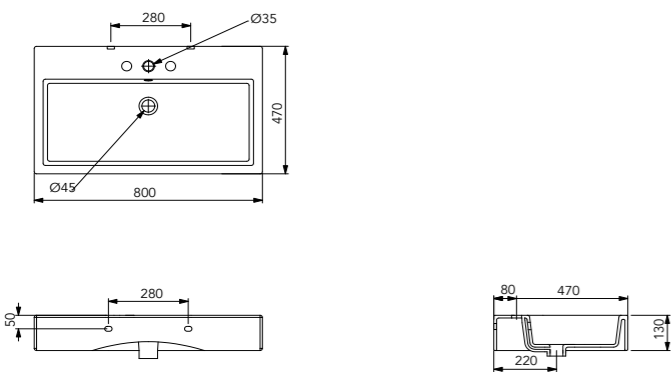

cod. QULAV80

cod. ZELAVBW102  
Lavabo Zenith bordo fino cm102  
Zenith washbasin cm102 thin edge

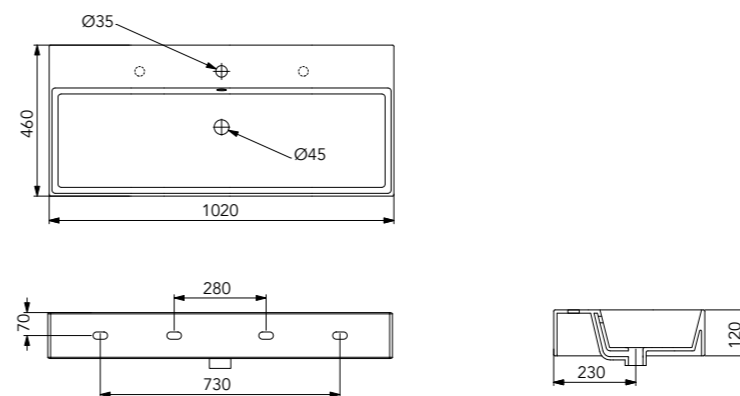

cod. ZELAVBW102

**cod. BXSCBW**  
Supporto singolo destro o sinistro in ceramica per lavabo a colonna a parete.  
*Single ceramic support left or right for column Washbasin back to wall.*

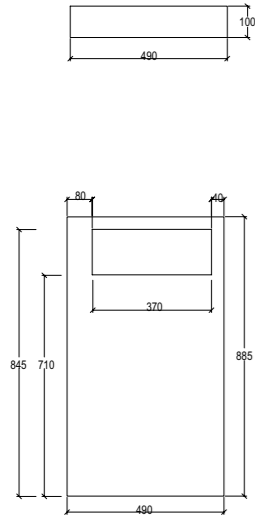

**cod. BXSCFS**  
Supporto singolo destro o sinistro in ceramica per lavabo a colonna centro stanza.  
*Single ceramic support left or right for column Washbasin free standing.*



**cod. BXSCFS/BXSCBW**



**cod. BXME**  
Mensola di supporto singola in ceramica per lavabi da appoggio o sospesi Box  
*Single ceramic shelf for countertop or wall hung Washbasin Box*

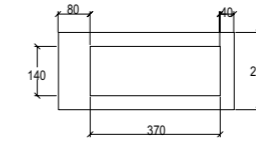
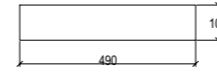

**cod. BXME**



LE MISURE INDICATE POSSONO VARIARE DEL 2% CIRCA, PER USURA STAMPI E PER VARIAZIONI DELLE CARATTERISTICHE TECNICHE DELLE MATERIE PRIME.

THE INDICATED SIZE COULD HAVE A VARIATION OF ABOUT 2% DUE TO THE USURE OF MOULDS AND VARIATIONS IN THE RAW MATERIALS.



# GSG

## CERAMIC DESIGN

### Controllo Qualità - *Quality passed*

Ogni prodotto GSG Ceramic Design è sottoposto ai test di alta qualità di GSG Ceramic Design per essere conforme alla normativa UNI.

*Any GSG Ceramic Design product is tested to match the GSG high quality controls and to be conform to UNI standards*

### Garanzia - *Warranty*

In osservanza della Direttiva Europea 1999/44/CE, recepita in Italia con D. lgs n. 206 del Codice di Consumo, GSG Ceramic Design riconoscerà eventuali difetti di conformità dei propri prodotti che si dovessero manifestare entro il termine di 24 mesi dalla loro vendita al cliente finale. L'unica spettanza di GSG Ceramic Design per tali pezzi è la loro sostituzione.

*In observance of European Directive 1999/44/EC, implemented in Italy with Legislative Decree no. 206 of the Consumer's Code, GSG Ceramic Design will recognize any lack of conformity of their products that may be found within the period of 24 months from their sale to the end customer.*

*The only pertaining of GSG Ceramic Design for these pieces is their replacement.*

### Manutenzione - *Maintenance*

I sanitari GSG Ceramic Design con la loro smaltatura di altissima qualità possono essere puliti perfettamente con semplice acqua tiepida e sapone o detersivo non abrasivo. L'uso di detersivi abrasivi per la pulizia danneggia la smaltatura.

*GSG Ceramic Design sanitary ware due to its high quality glazing can be perfectly cleaned with simple warm water and soap or non-abrasive detergent. The use of abrasives detergents for cleaning damage the glazing.*

### NOTES

Stampato su carta certificata proveniente da foreste gestite in modo sostenibile.

*Printed on certified paper from sustainably managed forests.*

Il marchio ed il logo GSG Ceramic Design sono marchi registrati.

GSG Ceramic Design diffida l'utilizzo dei propri marchi, loghi, nomi di dominio e ragione sociale anche dove non registrati.

I diritti di riproduzione di fotografie o testi contenuti in questo catalogo appartengono esclusivamente a GSG Ceramic Design.

Qualsiasi uso o riproduzione di fotografie o testi contenuti in questo catalogo senza il previo consenso di GSG Ceramic Design è espressamente vietata e soggetta alla normativa sul copyright intellettuale.

*The brand and the GSG Ceramic Design logo are registered trademarks.*

*GSG Ceramic Design distrusts the use of its trademarks, logos, and company domain names even where not registered.*

*reproduction rights of photos or texts contained in this catalog belong exclusively to GSG Ceramic Design.*

*Any use or reproduction of photos or texts contained in this catalog without prior written approval of GSG Ceramic Design is expressly prohibited and subject to the laws on intellectual copyright.*

GSG Ceramic Design si riserva il diritto di apportare upgrade tecnici ai propri prodotti senza alcun preavviso.

*GSG Ceramic Design reserves the right to make technical upgrades to its products without prior notice.*

### MADE IN EU

GSG Ceramic Design s.r.l. Via Brunelleschi, 27  
01033 Civita Castellana (VT) Italia  
Tel. + 39 0761/515258

www.ceramicagsg.it e-mail: info@ceramicagsg.it

Le nostre certificazioni:  
Our certifications:

ISO9001 : 2008



**AD: Massimiliano Abati**

**Studio Tecnico: GSG ceramic design**

**Foto: Roberto Costantini**

**Print: Telligraf**



[www.ceramicagsg.it](http://www.ceramicagsg.it)





**GSG**  
CERAMIC DESIGN

GSG Ceramic Design srl  
Via Brunelleschi 27 - 01033 - Civita Castellana (VT) -  
Italy Tel +39 0761 515258 - 516194 [www.ceramicagsg.it](http://www.ceramicagsg.it) -  
[info@ceramicagsg.it](mailto:info@ceramicagsg.it)

